

BACK-LIGHT

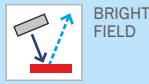







BRIGHT FIELD

BKC SERIES

Cylindrical backlights

















Cylindrical backlights that emit homogeneous diffuse lighting in the 360° of their circular surface, allowing their use from several angles at the same time, for complete backlight inspection of hollow objects such as pipes, deposits and boxes or for inspection from different angles in carousels or turntables.

► Technical specifications¹

Lighting model	BKC0806A
	
Dimensions	Ø60x100
Active surface	Ø60x60
Weight	260g
IP rating	IP40
Mounting holes	2 x M4I6
Connection (Type C/S)	2P male chassis connector PIN 1 = +24V ±3% PIN 2 = 0V
Power cable (Not-included)	VCB Series
Accessories ²	
Driver iBlueDrive ³	inline ST00
iBlueDrive connection	3P aerial male inline connector. PIN 1 = +24V ±8% PIN 2 = 0V PIN 3 = Control ⁴
iBlueDrive power cable (Not-included)	VCC Series
iBlueDrive accessories ²	  

► Instantaneous consumption⁵ (max.)

*WT

Lighting model	BKC0806A		
TYPE C 24VDC		7.4W	-470C
		11W	-525C
		5.3W	-630C
		6.4W	-850C
		7.4W	-W00C
TYPE P	No "Type P" standard LED lighting systems in this series		
TYPE S D _{max} = 1/10 Ton max= 2ms		1760mA/42W	-470S
		1760mA/42W	-525S
		1760mA/42W	-630S
		2020mA/48W	-850S
		1760mA/42W	-W00S
TYPE i ⁶ 		9.1W[48W/6.7W]	-470i
		15W[48W/10W]	-525i
		15W[48W/10W]	-630i
		15W[48W/7.7W]	-850i
		15W[48W/10W]	-W00i

(1) Environmental specifications and iconography legend in additional annex Z4.

(2) Accessories are not-included. More information in accessories section.

(3) inLine technical drawing and specifications in additional annex Z3.1.

(4) iBlueDrive control input wiring specifications in additional annex Z2.1.

(5) Bear in mind that consumption table is only to be used as a guide. To refer to real values, please, consult product label when purchasing.

(6) Values of maximum instantaneous consumption of "Type i" lighting systems in **Powered mode (Strobe mode / Continuous mode)**



BKC SERIES

* In the iBlueDrive version, the aerial cable integrates the inLine driver ST00, more info in additional annex Z3.1

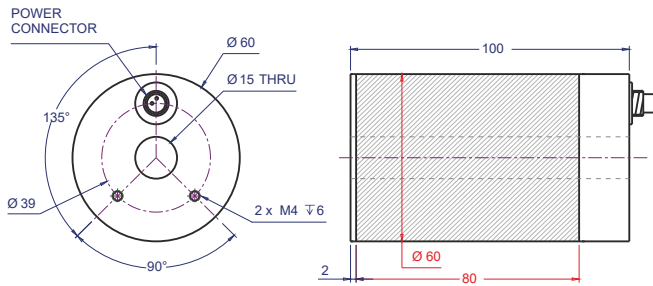

BKC0806A-E00B

All units in millimeters, if not indicated.

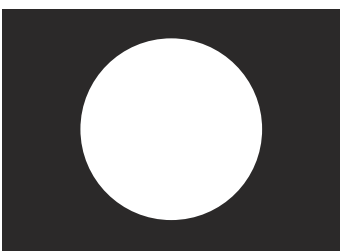

Example of BKC captured image

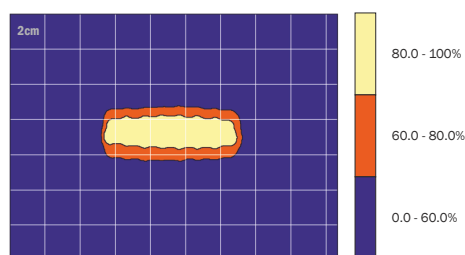

Brightness distribution of BKC0806A-630C



► Z1.1 - Control input NPN/PNP for 'Type C' lighting systems of DOL, PLA (PLA0513A and PLA1026A), PLC, PRC (PRC0604C and PRC0606B), PRH and PRK series.

■ NPN model (by default)

NPN chart of Vcontrol (Volts) vs Icontrol (mA)

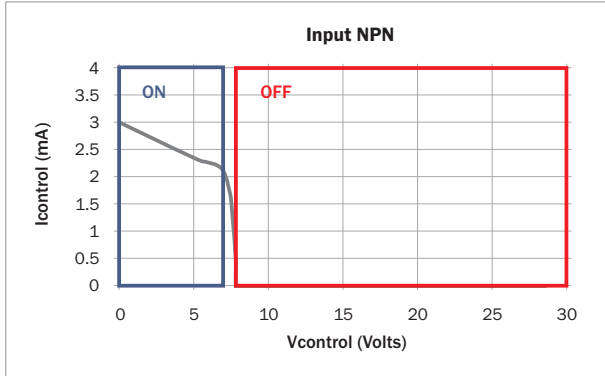

NPN wiring for ON/OFF mode

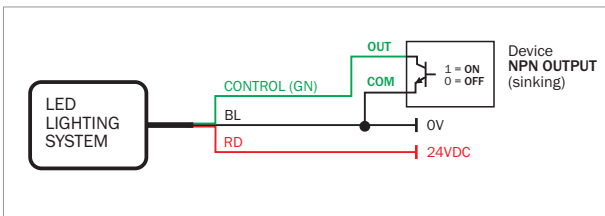

Electrical specifications

0V to +6.8V	Light ON
+7.2V to +24V	Light OFF
Working conditions	25°C, VIN = 24V
Connection	Direct to a NPN output
Delay from OFF to ON state	<5 µs
Delay from ON to OFF state	<5 µs
Bias voltage in control input	7.9V
Input impedance	7K9 Ω

■ PNP model (lighting systems with PNP modifier =/P)

PNP chart of Vcontrol (Volts) vs Icontrol (mA)

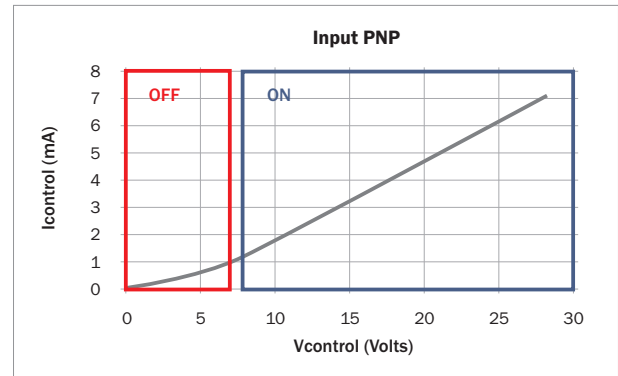

PNP wiring for ON/OFF mode

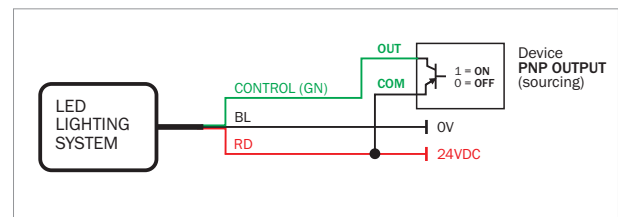

Electrical specifications

0V to +6.8V	Light OFF
+7.2V to +24V	Light ON
Working conditions	25°C, VIN = 24V
Connection	Direct to a PNP output
Delay from OFF to ON state	<5 µs
Delay from ON to OFF state	<5 µs
Bias voltage in control input	0V
Input impedance	4K Ω
Compliance	IEC1131-2 Type 1, 2 and 3

► Z2.1 - iBlueDrive control input wiring

All iBlueDrive products come together with a quick-start guide for connection and working conditions. Refer to iBlueDrive Manual for extended information.

NPN wiring for strobe or ON/OFF mode

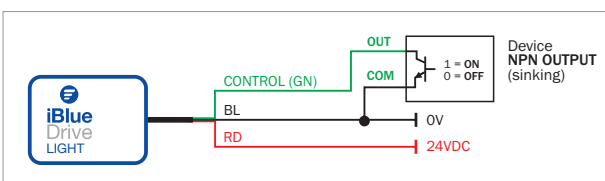

TTL wiring for strobe or ON/OFF mode

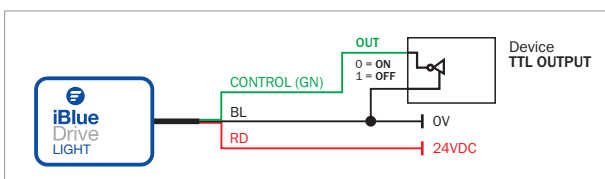

PNP wiring for strobe or ON/OFF mode

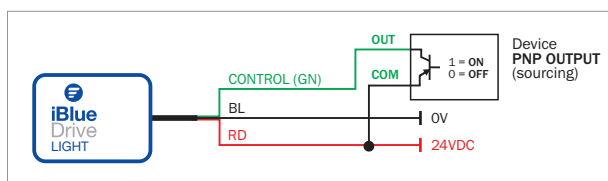

Wiring for continuous mode

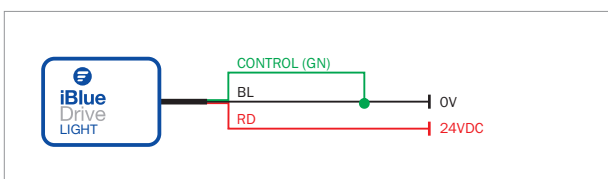

► Z2.2 - iBlueDrive Accessories legend

Icon			
Description	Accessory to configure iBlueDrive devices: iBlueDrive Box / iBlueDrive USB	iBlueDrive optocoupler	iBlueDrive potentiometer
Serie/Product	VTA0005A, VTA0006A / VTA0007A	VTA0020A	VTA0030B

► Z3.1 - Driver inline

Driver on the aerial connector cable for iBlueDrive and continuous type equipment.

The driver is placed in the cable that connects the lighting with the connector, it contains the control electronics of the device and is used when it is not possible to integrate it inside the lighting in both iBlueDrive and continuous types. Functionally, there is no difference between lightings with inLine or integrated driver.

The inline driver is in charge of managing the power of the device, therefore it is advisable to fix it to a metal structure to improve the heat dissipation that it produces.

There are 6 different models of inline drivers and each of them is used with a particular lighting model, depending on its power needs or environment in which it will be used.

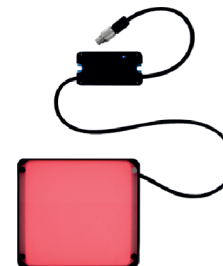

Standard (St00)

Standard driver used in most of the equipment with external driver both in continuous type and iBlueDrive.

Used in ALD, ALS, ALU, ALW, AUB, BKC, BKL* , DKL, DOM0906A, DOM1410A, DOM1613A, DOM2414A, PLA, PLD, PLU, PRF (iBlueDrive) , PRY, SAC, SAL*.
*except BKL0303A, BKL2515A and SAL0202A

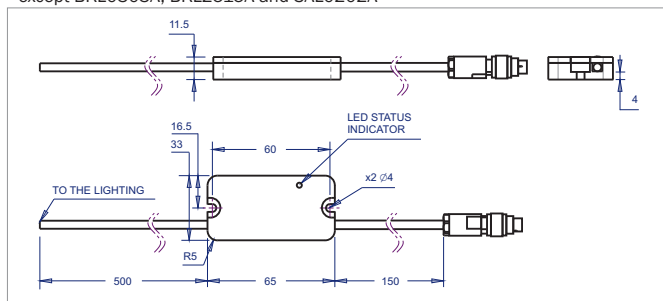

Standard IP67 (St01)

IP67 standard driver used in most of the devices with external driver in both continuous type and iBlueDrive that require IP65/IP67 protection.

Used in BKL* , DOM0906A, DOM1410A, DOM1613A, DOM2414A, PRD0500B.
*except BKL0303A and BKL2515A

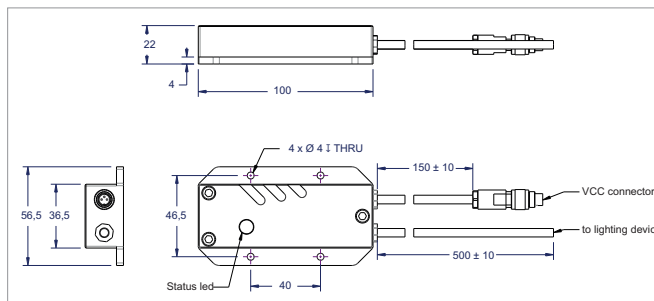

Low Power (LP)

Low power driver used in most of the equipments that have external driver both in continuous type and iBlueDrive that require less power.

Used in PRF (continuous), BKL0303A, PRA0818A, PRD0200A and SAL0202A.

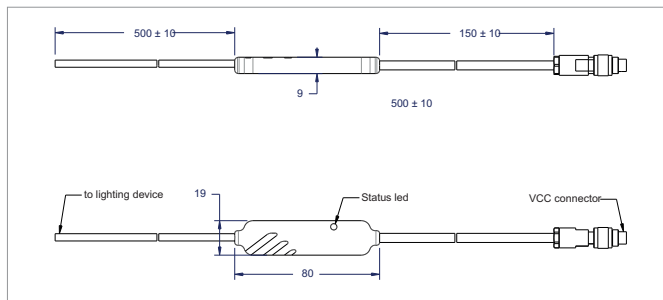

High power driver

High power driver used in most of the equipments that have external driver both in continuous type and in iBlueDrive that require more power.

Used in DOM1613A.

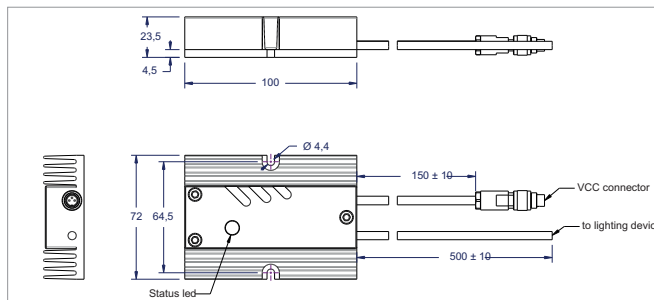

High Power IP67(HP01)

High power driver used in most of the equipments that have external driver both in continuous type and iBlueDrive that require more power and IP65/IP67 protection.

Used in DOM1613A.

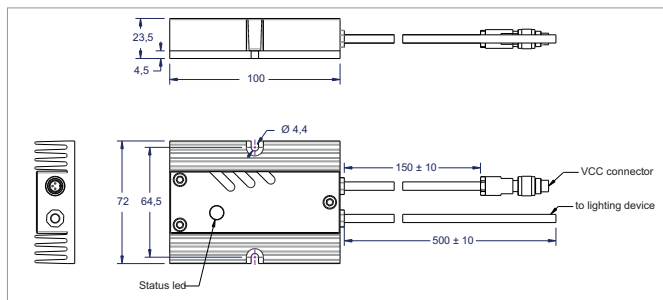

Multisector (SE)

Driver used in most of the equipments that have external driver in iBlueDrive type in its multisectorial versions (both RGB and 4 sectors).

Used in DKL1813A, DOM0906A y DOM1410A

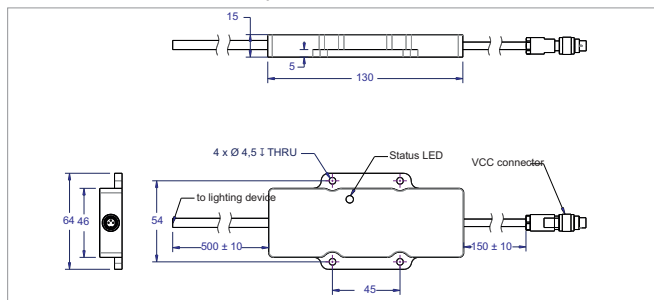

WARNING! In continuous and powered mode, clamp driver to a metal surface for heat dissipation. In Strobe mode is not required, but recommended.



► Z4.1 - Environmental Specifications

Max. Operating Humidity	85% non-condensing
Operating Temperature	0 - 40°C
Storage Temperature	0 - 60°C
Housing material	Anodized aluminium
Standards	

► Z4.2 - Modifiers legend

icon	Description	Code
	Narrow angle of emission	/AN
	Medium angle of emission (default)	/AM
	Wide angle of emission	/AW
	Diffuse emission	/AD
	Polarizer filter	/FPL
	Diffuser filter	/FDR
	Backlight hole of 42mm	/H
	Backlight hole of 65mm	/H1
	Dome hole of 46mm	/CC1
	Dome hole of 40mm	/CC2
	IP Rating = IPxx = Ip65 / IP67	/65 / 67
	PNP input model	/P
	50mm focal Length	/F1
	150mm focal Length	/F2
	Infinite focal Length	/F3
	Lighting by sectors = 4 sectors	/4S

► Z4.3 - Accessories legend

icon	Description	Serie
	Power cable/s	VCB, VCC, VCD Series
	Other cable/s	VCU, VCL
	Strobe and RGB controller/s	VST, VSC Series
	Polarizer filter	VPF, VPC
	Diffuser filter	VDF
	Collimater filter on x axis, y axis or both	VCF
	Darkfield converter	VRF
	Protector filter	VPT
	Heat dissipator	VHD
	Fixing bracket	VBA, VBB, VBC Series

► Z4.4 - Technical drawings legend

icon	Description
	Optical axis
	Viewing window dimensions
	Lighting elements
	Light emission center
	Lighting surface dimensions

► Z4.5 - Colours & Wavelegths legend

icon	Wavelength	Colour	Code
	365nm	UV-	-365
	400nm	UV	-400
	470nm	BLUE	-470
	525nm	GREEN	-525
	630nm	RED	-630
	850nm/880nm	IR	-850/-880
		WHITE	-W00
		RGB	-RGB

► Z4.6 - Types of lighting legend

icon	Description
	Radial lighting
	'Darkfield' lighting effect. Low angle illumination
	Backlight illumination
	'Cloudy day' lighting effect
	'Bright field' lighting effect
	Projector lighting
	Axial lighting

► Z4.7 - Types of light legend

icon	Description
	Direct light
	Diffuse light
	Ultra-diffuse light



MACHINE VISION SHOP

FOR ALL YOUR VISION PRODUCTS

Thank you for downloading this document from
www.machine-vision-shop.com

If you have any questions, you need help composing the right package for your application or do you want to order?

Feel free to contact us via e-mail at
sales@vision-consultancy.nl or visit our webshop.

Our vision experts are happy to help you.



Natascha Overhof



Christian Cromptoets



Machine Vision Shop

Trade name of Vision Consultancy BV

Robert Schumandomein 2
6229 ES Maastricht
The Netherlands

+31 (0) 438 522 651

sales@vision-consultancy.nl
www.machine-vision-shop.com

Scan me to visit
[machine-vision-shop](http://machine-vision-shop.com)

