



RICOH International B. V., German Branch

# Machine Vision

Lenses  
Accessories  
Technical Information

**RICOH**  
imagine. change.

## **MACHINE VISION LENSES 4**

VGA Lenses, Fixed Focal Length, Manual Iris .....	6
2 Megapixel Lenses, 1/2" and 2/3", Fixed Focal Length, Manual Iris .....	8
2 Megapixel Lenses, all 2/3", Fixed Focal Length, Manual Iris .....	10
5 Megapixel Lenses, Fixed Focal Length, Manual Iris.....	12
Exceeding 5 Megapixel Lenses, Fixed Focal Length, Manual Iris.....	14
9 Megapixel (12 Megapixel 1.1") Lenses, Fixed Focal Length, Manual Iris.....	17
2 Megapixel Lenses, Set, Boxed .....	20
9 Megapixel (12 Megapixel 1.1") Lenses, Set, Boxed .....	20
Line-Scan Lenses, Format 45 mm.....	21
High Performance UV Lenses.....	22
6X Zoom Lenses, Manual .....	23

## **MACHINE VISION ACCESSORIES 25**

Focal Length Extender, Adaptor, Tools .....	26
For close-up applications: Macro Reversing Ring.....	26
For close-up applications: Extension Tubes, Macro Focus Mount .....	27
Polarising Filters .....	28
UV Blocking Filters .....	28
Colour Filters.....	29

## **TECHNICAL INFORMATION 30**

Technical Information.....	30
Conversion Table For Horizontal Angle Of View .....	38
Optical Calculations for Close-Up Applications .....	41

# MACHINE VISION LENS LINE UP

## Lenses for Machine Vision

For each resolution level VGA, 2MP, 5MP and 9MP (12MP 1.1"), the RICOH FL Series provides an extensive line of high-performance lenses with different focal lengths and sensor sizes.

Knowhow developed in our camera operations has been put to good use in creating high-quality products with an extremely low level of variation among individual lenses.



# Machine Vision Lenses



Pictures not true to scale

- VGA Lenses
- 2 Megapixel Lenses
- 5 Megapixel Lenses
- Exceeding 5 Megapixel Lenses
- 9 Megapixel (12 Megapixel 1.1") Lenses
- Line-scan Lenses
- UV Lenses

# VGA LENSES MANUAL IRIS

An extensive line of general-use lenses boasting high-performance lens technology featuring vibration-control measures, these lenses are a superior choice for installation in machine vision systems.

Built for a wide variety of uses, including pattern matching, component positioning, missing-part inspection, board mounting and inspection of pharmaceuticals, produce, and grains.

- Standard lenses for machine vision use
- Compatible with VGA-class cameras
- Production line handling cameras from 1/2" to 1" formats
- Lock screws as standard vibration-control measures

## VGA LENSES, FIXED FOCAL LENGTH Manual Iris, with Locking Screws

Part No.	Format size	Mount	Focal length (mm)	Iris range	Min. Pixel Pitch (µm)*	M. O. D. (m)	Horizontal angle of view	Filter size (mm)	Dimensions (mm)	Price (Euro)
❶ FL-HC0416X-VG	1/2"	C	4.2	1.6 - C	8.75	0.2	86.8°	-	Ø42.0 × 43.5	171.00
FL-HC0612A-VG	1/2"	C	6.0	1.2 - C	8.75	0.2	56.9°	40.5	Ø42.0 × 46.0	156.00
FL-HC1212B-VG	1/2"	C	12.0	1.2 - 22	8.75	0.2	30.2°	27.0	Ø30.0 × 35.5	116.00
❶ FL-CC0418DX-VG	2/3"	C	4.8	1.8 - C	11.67	0.3	96.4°	-	Ø40.5 × 35.5	183.00
FL-CC0815B-VG	2/3"	C	8.5	1.5 - C	11.67	0.2	56.5°	40.5	Ø42.0 × 40.0	132.00
FL-CC1614A-VG	2/3"	C	16.0	1.4 - 22	11.67	0.3	30.7°	27.0	Ø30.0 × 33.0	109.00
FL-BC1214D-VG	1"	C	12.5	1.4 - C	17.50	0.3	54.0°	40.5	Ø42.0 × 50.0	203.00
FL-BC1218A-VG	1"	C	12.5	1.8 - C	17.50	0.3	55.5°	40.5	Ø42.0 × 40.0	168.00
FL-BC2514D-VG	1"	C	25.0	1.4 - 22	17.50	0.3	30.0°	27.0	Ø30.0 × 37.3	136.00
FL-BC2518-VG	1"	C	25.0	1.8 - C	17.50	0.6	28.2°	40.5	Ø42.0 × 40.0	140.00
FL-BC5014A-VG	1"	C	50.0	1.4 - C	17.50	1.0	14.4°	46.0	Ø48.0 × 48.0	189.00

\* Min. Pixel Pitch at 30% contrast (measuring on the edge of the Optic), ❶ fixed focus

Unit: mm

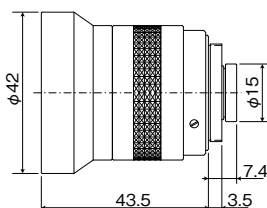

FL-HC0416X-VG

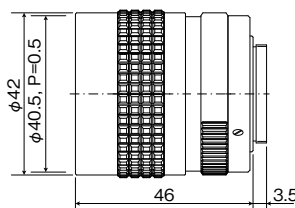

FL-HC0612A-VG

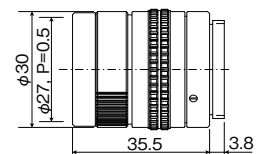

FL-HC1212B-VG

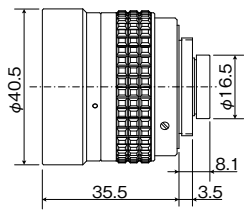

FL-CC0418DX-VG

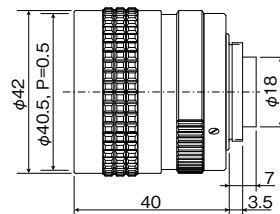

FL-CC0815B-VG

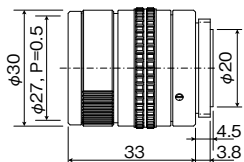

FL-CC1614A-VG

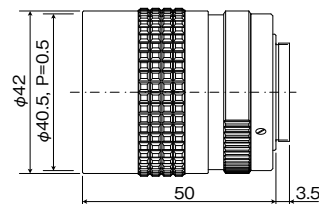

FL-BC1214D-VG

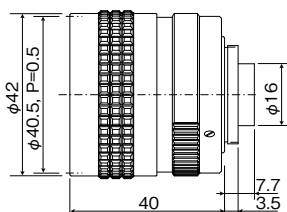

FL-BC1218A-VG

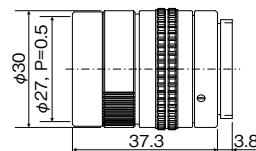

FL-BC2514D-VG

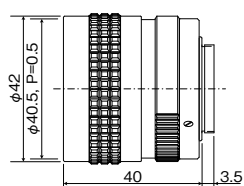

FL-BC2518-VG

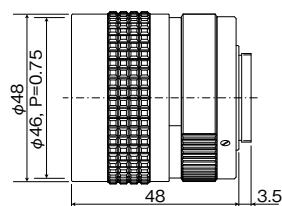

FL-BC5014A-VG

# 2 MEGAPIXEL LENSES

## 1/2" AND 2/3"

2 megapixel type lenses for a wide range of applications: Select the optimum lens for your focal length and format size requirements.

These manual-iris lenses are an optimal choice for image processing data capture at 2 megapixels. With their compact size and high performance, they deliver great results for high-precision manufacturing inspection (chip mounters, wafers, electronic substrates, etc.).

- High-performance lenses for close-up imaging with 2 megapixel CCD and CMOS sensors
- Sharp high resolution, high contrast images, that limit resolution loss from the center to periphery
- With compact size, light weight, and durability, these are excellent lenses for FA and machine vision use
- They greatly reduce distortion that causes problems in image measurement and recognition
- Built to handle environments with vibration, etc.
- Easy to use, reliable focus and iris locking mechanisms as standard features

## 2 MEGAPIXEL LENSES, FIXED FOCAL LENGTH

### Manual Iris, with Locking Screws

Part No.	Format size	Mount	Focal length (mm)	Iris range	Min. Pixel Pitch (μm)*	M. O. D. (m)	Horizontal angle of view	Filter size (mm)	Dimensions (mm)	Price (Euro)
----------	-------------	-------	-------------------	------------	------------------------	--------------	--------------------------	------------------	-----------------	--------------

#### HIGH-RESOLUTION, FOR STANDARD, IP AND MEGAPIXEL CAMERAS

FL-HC0614-2M	1/2"	C	6	1.4 - 16	5.39	0.10	57.4°	-	Ø32.0 × 37.5	159.00
FL-HC1214-2M	1/2"	C	12	1.4 - 16	5.39	0.25	28.9°	27.0	Ø29.5 × 28.5	152.00
FL-CC1614-2M	2/3"	C	16	1.4 - 16	5.39	0.25	31.0°	27.0	Ø29.5 × 33.2	152.00
FL-CC2514-2M	2/3"	C	25	1.4 - 16	5.39	0.25	20.0°	27.0	Ø29.5 × 32.0	162.00
FL-CC3516-2M	2/3"	C	35	1.6 - 16	5.39	0.40	14.8°	27.0	Ø29.5 × 35.4	162.00
FL-CC5028-2M	2/3"	C	50	2.8 - 22	5.39	0.90	10.1°	27.0	Ø29.5 × 34.0	169.00
FL-CC7528-2M	2/3"	C	75	2.8 - 32	5.39	0.70	6.9°	30.5	Ø34.0 × 59.6	339.00

\* Min. Pixel Pitch at 30% contrast (measuring on the edge of the Optic)

Unit: mm

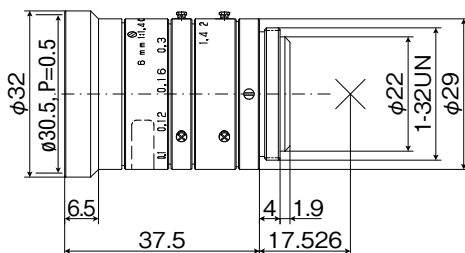

FL-HC0614-2M

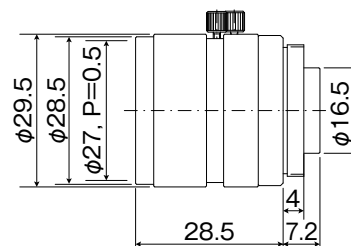

FL-HC1214-2M

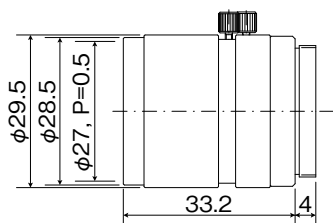

FL-CC1614-2M

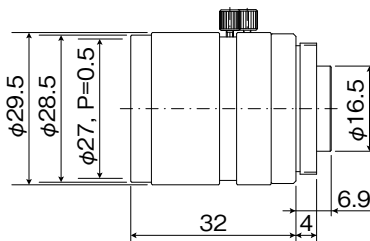

FL-CC2514-2M

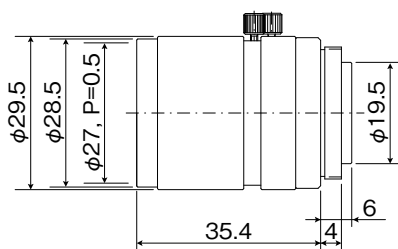

FL-CC3516-2M

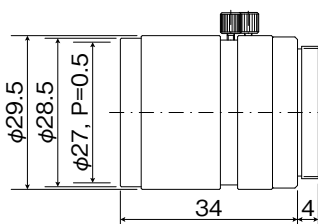

FL-CC5028-2M

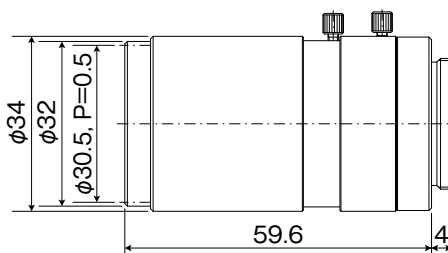

FL-CC7528-2M



# 2 MEGAPIXEL LENSES

## ALL 2/3"

The new lenses following customer's requests now consistently have a 2/3" format, expanding the line-up next to the existing and very successful 2 Megapixel series. With the new lens design, all values are again improved, so the lenses are ideal for a wide range of applications.

- **Bright images from the center to the edges:**  
Degradation of light transmission at the periphery has been kept to an absolute minimum enabling the new lenses to reproduce bright, high resolution images from the center to the periphery.

- **High Resolution and High Contrast even at the periphery:** Minimal degradation of resolution and contrast right through to the periphery. Therefore, even images right on the periphery are suitable for measurement and inspections.
- **Shortened MOD (Minimum Objective Distance):** Thanks to the newly developed optics, MODs have been shortened to 0.1m (except FL-CC5024A-2M), enabling further close-up imaging without the need for distance rings.
- **Low distortion:** Troublesome distortion for measurement and recognition applications has been reduced (0.02% to max. 0.56%).

## 2 MEGAPIXEL LENSES, FIXED FOCAL LENGTH

### Manual Iris, with Locking Screws

Part No.	Format size	Mount	Focal length (mm)	Iris Range	Min. Pixel Pitch (µm)*	M. O. D. (m)	Horizontal angle of view	Filter size (mm)	Dimensions (mm)	Price (Euro)
<b>HIGH-RESOLUTION, FOR STANDARD, IP AND MEGAPIXEL CAMERAS</b>										
FL-CC0614A-2M	2/3"	C	6	1.4-16	5.39	0.1	71.2°	-	Ø 48.0 x 59.9	174.00
FL-CC0814A-2M	2/3"	C	8	1.4-16	5.39	0.1	56.3°	40.5 P=0.5	Ø 42.0 x 36.7	167.00
FL-CC1214A-2M	2/3"	C	12	1.4-16	5.39	0.1	39.4°	27.0 P=0.5	Ø 29.5 x 45.7	152.00
FL-CC1614A-2M	2/3"	C	16	1.4-16	5.39	0.1	30.7°	27.0 P=0.5	Ø 29.5 x 32.2	152.00
FL-CC2514A-2M	2/3"	C	25	1.4-16	5.39	0.1	19.5°	30.5 P=0.5	Ø 32.0 x 38.0	162.00
FL-CC5024A-2M	2/3"	C	50	2.4-22	5.39	0.3	10.3°	30.5 P=0.5	Ø 32.0 x 46.5	169.00

\* Min. Pixel Pitch at 30% contrast (measuring on the edge of the Optic)

Unit: mm

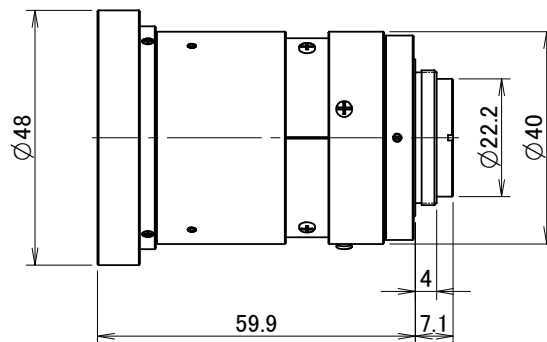

FL-CC0614A-2M

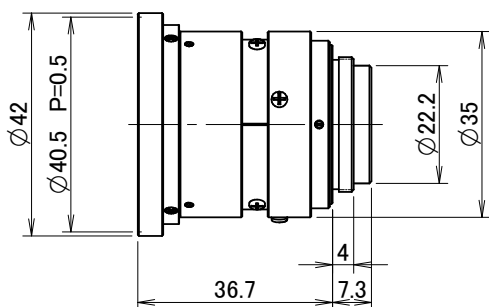

FL-CC0814A-2M

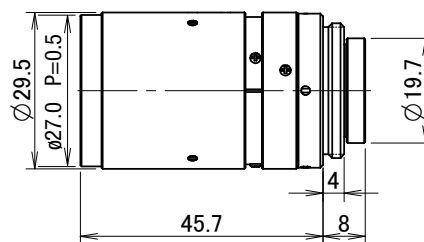

FL-CC1214A-2M

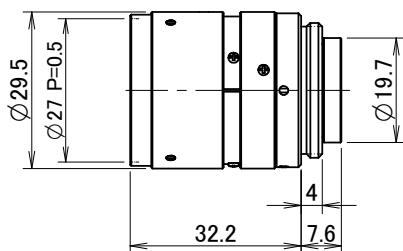

FL-CC1614A-2M

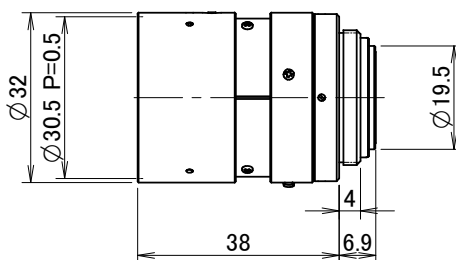

FL-CC2514A-2M

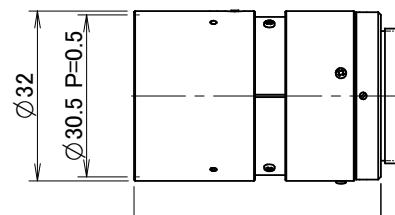

FL-CC5024A-2M

# 5 MEGAPIXEL LENSES

This series of high-res lenses are designed to match the requirements of highly developed machine vision systems. The lens isn't only optimized for highest image quality, but also for heavy duty industrial operation.

They are perfect for inspection, pattern matching, and alignment uses in which images with high definition from edge to edge definition are needed for large subjects such as wafers, chip mounters, board mounting, etc.

- Compatible with pixel size 3.45µm, 5 megapixel on 2/3" cameras
- High resolving power of 140 lp/mm from centre to corners of the image
- FL-CC1614-5M, FL-C2514-5M: 1% or less distortion, suitable for image measurement
- 40% increased light distribution
- Fast aperture F1.4
- Ideal for integration in highly developed machine vision systems
- Stable design, robust and durable
- With locking and thumb screws

**FL-CC1614-5M Optical transfer function**

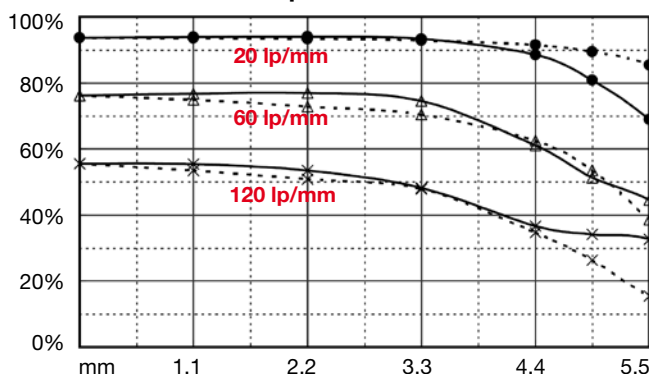

**FL-CC1614-5M Distortion**

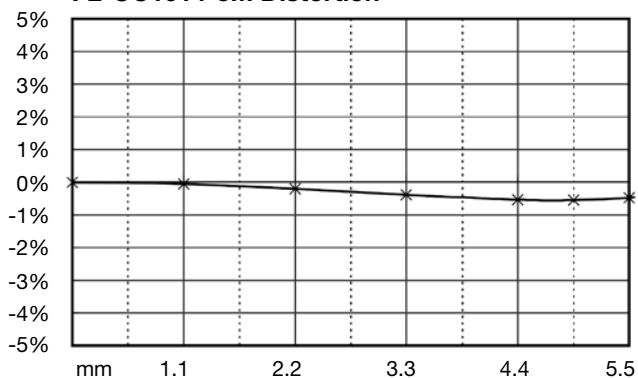

**Peripheral light intensity (Working distance 250 mm)**

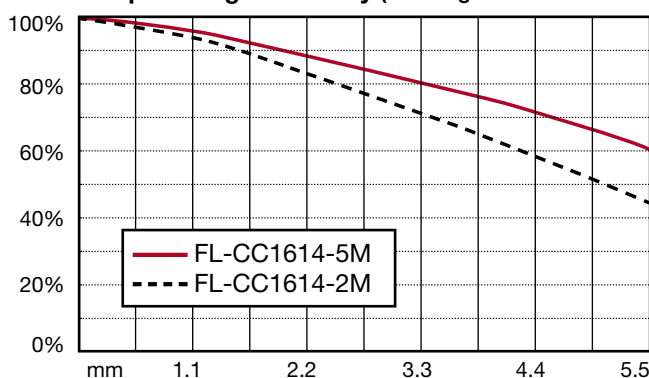

## High resolution and high contrast

Supports 2/3" format, 5 megapixel CCD camera with 3.45µm pixel pitch. Achieves 140 lp/mm high resolution from center to periphery. Produces sharp, high-clarity images with high-contrast and low resolution loss all the way to the edge.

## Ø 43 mm / 60 mm compact design

Consistent with the 44 mm-square cases used by many 5 megapixel cameras, we have achieved a size reduction to 43 mm for the outer diameter. These lenses are an excellent choice for installation on high-performance devices..

## Extremely small level of optical distortion

For both the FL-CC2514-5M and the FL-CC1614-5M, optical distortion on the diagonals is less than 1%. TV distortion is held to less than 0.2%. The resulting extremely low-distortion images are also excellent for use in the image measurement field.

## Bright to the periphery

Despite the 43 mm diameter, the optics accommodate 5 megapixels with F1.4 brightness. With peripheral-light-intensity falloff held to an absolute minimum, it is possible to obtain bright and high-resolution images. Although they are wide-angle lenses, with the iris open we were able to raise the peripheral light level to 70% (diagonals) and thereby achieve images that are bright and clear all the way to the periphery.

# 5 MEGAPIXEL LENSES, FIXED FOCAL LENGTH

## Manual Iris, with Locking Screws

Part No.	Format size	Mount	Focal length (mm)	Iris range	Min. Pixel Pitch ( $\mu\text{m}$ )*	M. O. D. (m)	Horizontal angle of view	Filter size (mm)	Dimensions (mm)	Price (Euro)
<b>HIGH-RESOLUTION, FOR STANDARD, IP AND MEGAPIXEL CAMERAS</b>										
FL-CC0814-5M	2/3"	C	8	1.4 - 16	3.45	0.1	57.8°	58.0	$\varnothing 60.8 \times 64.0$	499.00
FL-CC1614-5M	2/3"	C	16	1.4 - 16	3.45	0.1	30.8°	40.5	$\varnothing 43.0 \times 47.0$	399.00
FL-CC2514-5M	2/3"	C	25	1.4 - 16	3.45	0.1	19.9°	40.5	$\varnothing 43.0 \times 44.0$	399.00

\* Min. Pixel Pitch at 30% contrast (measuring on the edge of the Optic)

Unit: mm

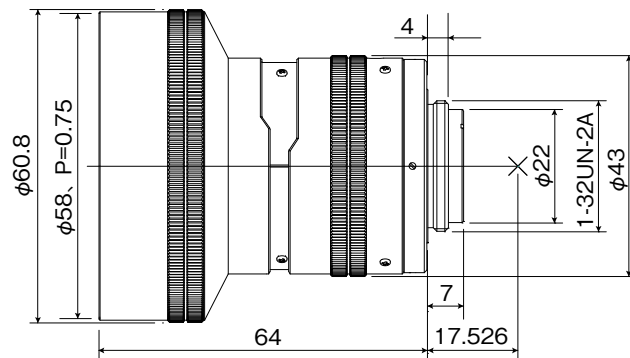

FL-CC0814-5M

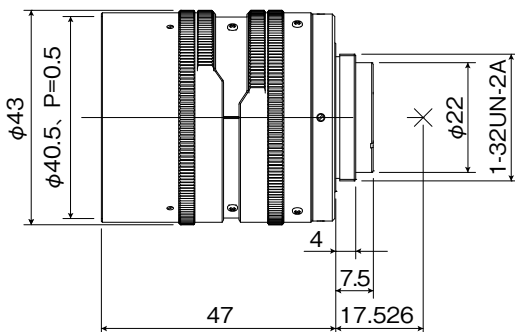

FL-CC1614-5M

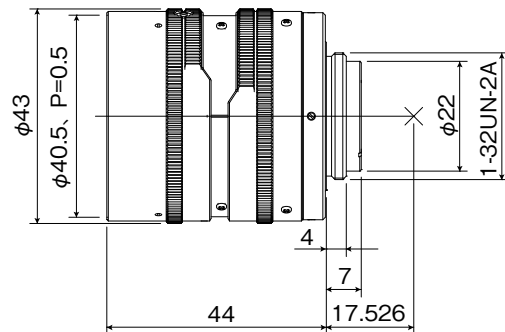

FL-CC2514-5M

# EXCEEDING 5 MEGAPIXEL LENSES

This series of exceeding 5 megapixel lenses are developed to be used with 2/3" format cameras and are not only optimised for high image quality, but also for use in harsh environments and durable industrial systems.

The lens's focusing uses a floating mechanism design, reducing aberrations from an infinite to close working distance. Therefore, the lenses can also be used at distance in intelligent traffic technology.

A floating focusing mechanism focuses whilst changing the spacing of some of its optical systems in order to minimize changes in aberrations due to object distance. The lens's construction is divided into a focus group that moves when focusing and a fixed group that remains stationary.

## FL-CC1218-5MX MTF Comparison

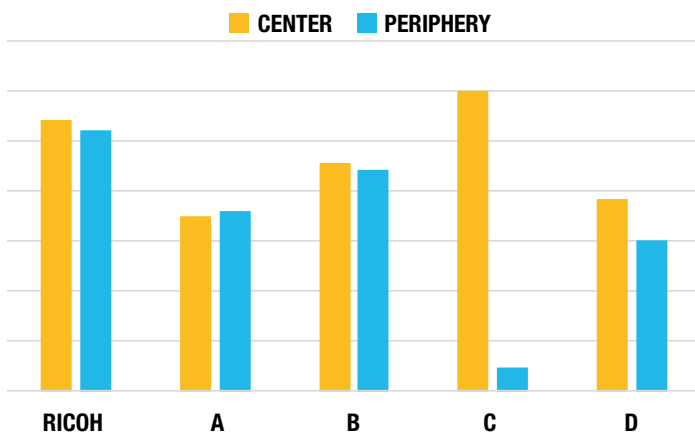

- [A] Competitors 5 MP Lens:  
Large distortion caused lower MTF result
- [B] Competitors 12 MP Lens
- [C] Competitors 5 MP Lens:  
High central MTF, very low peripheral MTF
- [D] Competitors 10 MP Lens

## FL-CC2518-5MX Distortion

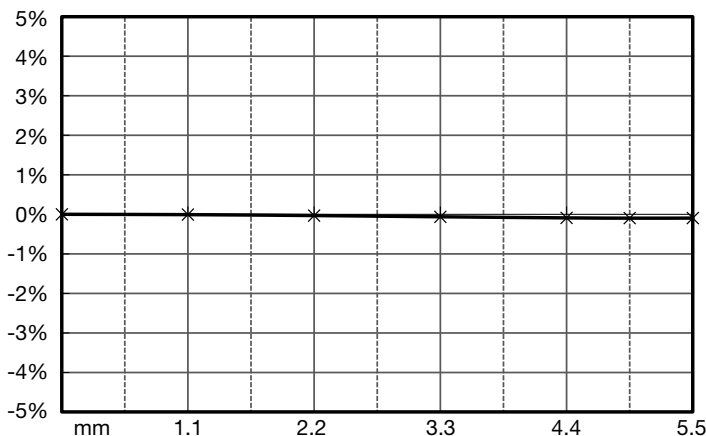

## New exceeding 5 megapixel lenses

- Focal Length 8mm, 12mm, 16mm, 25mm, 35mm
- Pixel Pitch 3.45 µm
- Ø 33 mm compact design, robust and durable with locking screws
- JIA S-Rank<sup>1</sup> Performance, 147 lp/mm from center to corners
- Even light distribution, bright and clear to the periphery
- Floating Focusing Mechanism produces high resolution images at all working distances
- Distortion less than 0.1%<sup>2</sup>

## Extremely low distortion

The optical distortion of this series is < 0.1%<sup>2</sup>. The resulting extremely low distortion images are excellent for use in the image measurement field.

## Compact design, Ø 33 mm

These lenses have a 33 mm compact design, ideal for installation with high performance equipment.

## Bright and clear to the periphery

Despite the small diameter of 33 mm, the vignetting has been reduced to the minimum. Combined with 5 megapixel resolution, bright, high contrast images are achieved all the way to the edges.

## High resolution and high contrast

Supports 2/3" format, 3.45 µm pixel pitch cameras, producing sharp 147 lp/mm high resolution, high contrast images from the center to the periphery.

1 JIA Technical Report LER-007: Recommended specifications for high definition camera lenses

- Applications (S-Rank): For applications requiring higher resolution over the entire image
- Evaluation Criteria (S-Rank): Resolving spatial frequency corresponding to the Nyquist frequency over the entire image

2 Except 8mm

## Lens vignetting (2/3" Sensor) at Fully Open vs F:4.0, F:5.6 and F:8.0

Despite the Ø 33mm compact design, vignetting has been reduced to the minimum.  
 F:5.6 and F:8.0 only shown when deviating from F:4.0

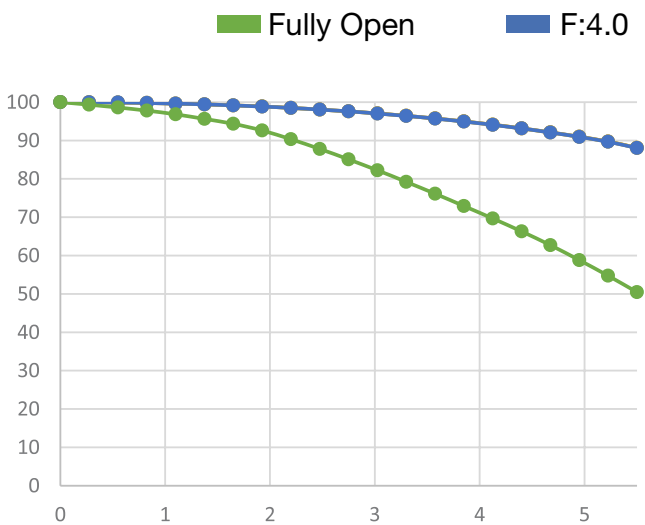

**FL-CC0820-5MX** W.D. = 250mm

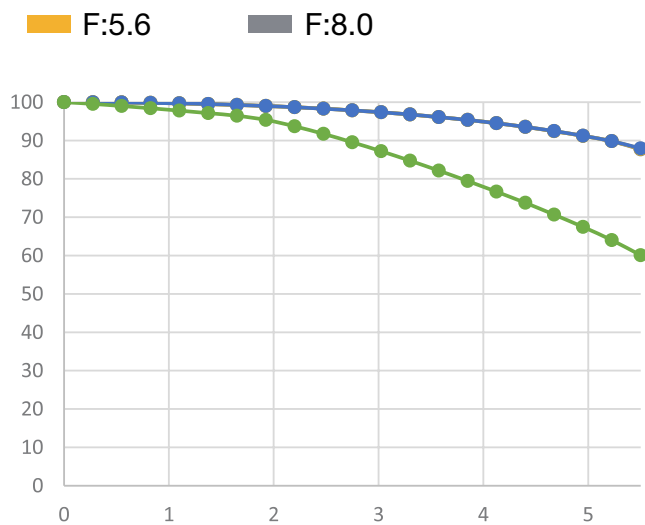

**FL-CC1218-5MX** W.D. = 250mm

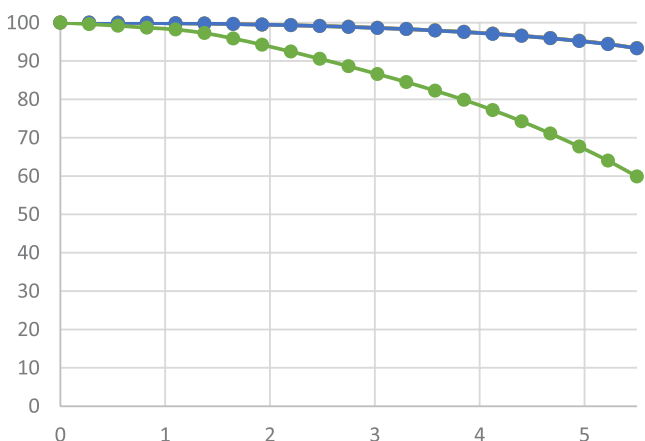

**FL-CC1618-5MX** W.D. = 250mm

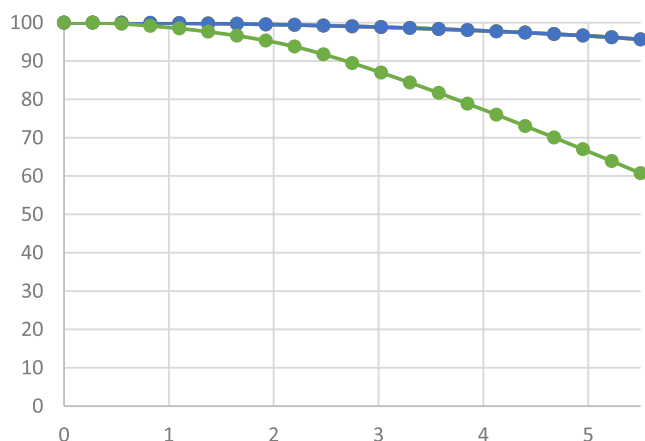

**FL-CC2518-5MX** W.D. = 250mm

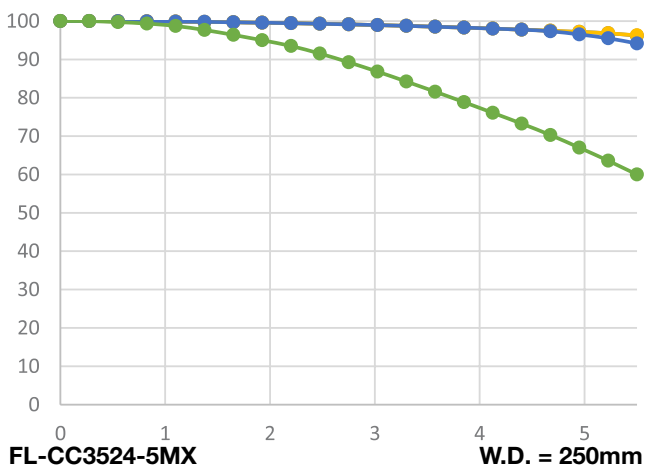

**FL-CC3524-5MX** W.D. = 250mm

W.D. = Working Distance

# EXCEEDING 5 MEGA PIXEL LENSES, FIXED FOCAL LENGTH

## Manual Iris, with Locking Screws

Part No.	Format size	Mount	Focal length (mm)	Iris range	Min. Pixel Pitch ( $\mu\text{m}$ )*	M. O. D. (m)	Horizontal angle of view	Filter size (mm)	Dimensions (mm)	Price (Euro)
<b>HIGH-RESOLUTION, FOR STANDARD, IP AND MEGA PIXEL CAMERAS</b>										
FL-CC0820-5MX	2/3"	C	8	2.0 - 16	3.45	0.1	58.5°	30.5	$\varnothing 33.0 \times 43.0$	349.00
FL-CC1218-5MX	2/3"	C	12	1.8 - 16	3.45	0.1	40.5°	30.5	$\varnothing 33.0 \times 47.0$	329.00
FL-CC1618-5MX	2/3"	C	16	1.8 - 16	3.45	0.1	30.9°	30.5	$\varnothing 33.0 \times 47.0$	329.00
FL-CC2518-5MX	2/3"	C	25	1.8 - 16	3.45	0.1	20.0°	30.5	$\varnothing 33.0 \times 50.0$	329.00
FL-CC3524-5MX	2/3"	C	35	2.4 - 16	3.45	0.1	14.3°	30.5	$\varnothing 33.0 \times 65.5$	329.00

\* Min. Pixel Pitch at 30% contrast (measuring on the edge of the Optic)

Unit: mm

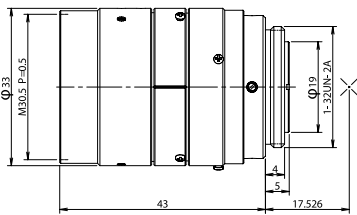

FL-CC0820-5MX

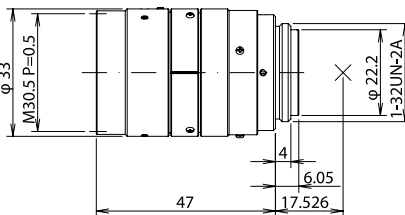

FL-CC1218-5MX

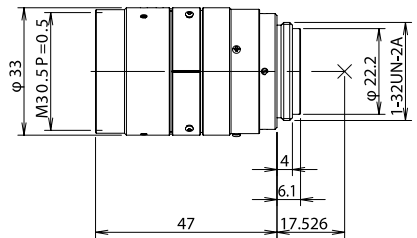

FL-CC1618-5MX

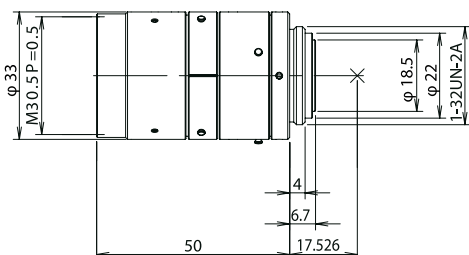

FL-CC2518-5MX

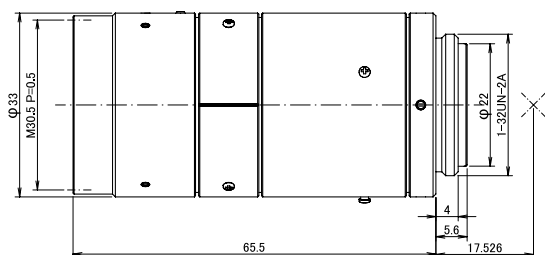

FL-CC3524-5MX

# 9 MEGAPIXEL LENSES (1") / 12 MEGAPIXEL LENSES (1.1")

This series of high resolution lenses are developed to be installed in machine vision systems with cameras with sensors up to 9 megapixels for 1" format / 12 megapixels for 1.1" format. The lenses are not only optimised for high image quality, but also for use in harsh environments and durable industrial systems.

These RICOH lenses are equipped with locking screws, to prevent unintended movement of focus and iris positions.

The lens's focusing uses a floating mechanism design, reducing aberrations from an infinite to close working distance. Therefore, the lenses can also be used at distance in intelligent traffic technology.

- Focal Lengths 12 mm, 16 mm, 25 mm, 35 mm, 50 mm, 75 mm
- Pixel Pitch 3.45  $\mu\text{m}$
- 147 lp/mm from centre to corners of the image
- Extremely low distortion, suitable for image measurement
- Even light distribution
- Locking Screws
- Ideal for integration in systems with large sensors (Suitable for Sony IMX253 sensor)
- Compact design, robust and durable

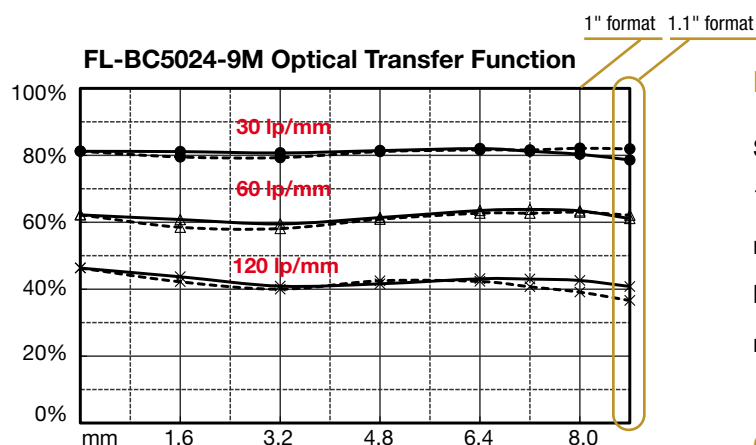

## High resolution and high contrast

Supports 1" format, 9 megapixel / 1.1" format, 12 megapixel cameras. Achieves 147 lp/mm high resolution from centre to periphery. Produces sharp, high-clarity images with high-contrast and low resolution loss all the way to the periphery.

## Compact design, $\varnothing$ 42 mm

To suit 44 mm housings used for most 12 megapixel cameras, these lenses have a 42 mm compact design ideal for installation with high performance equipment.

## Extremely low distortion

The optical distortion of this series is generally ~ 2%, (wide angle lens FL-BC1220-9M) or less, partially even < 0.1 %. The resulting extremely low-distortion images are excellent for use in the image measurement field.

## Bright and clear to the periphery

Despite the small diameter of 42 mm, vignetting has been reduced to the minimum. Combined with the 12 megapixel resolution, bright, high contrast images are achieved all the way to the edges.

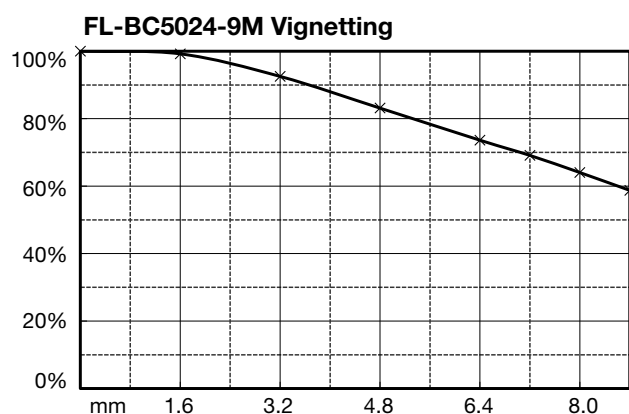
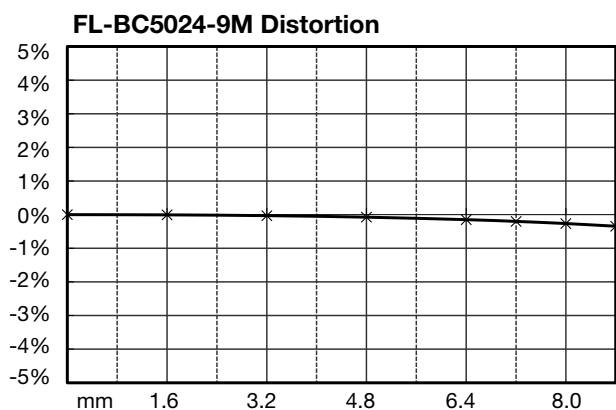



# 9 MEGAPIXEL LENSES (1" ) / 12 MEGAPIXEL LENSES (1.1" )

## Lens vignetting (1.1" Sensor) at Fully Open vs F:4.0, F:5.6 and F:8.0

Despite the Ø 42mm compact design, vignetting has been reduced to the minimum.  
F:5.6 and F:8.0 only shown when deviating from F:4.0

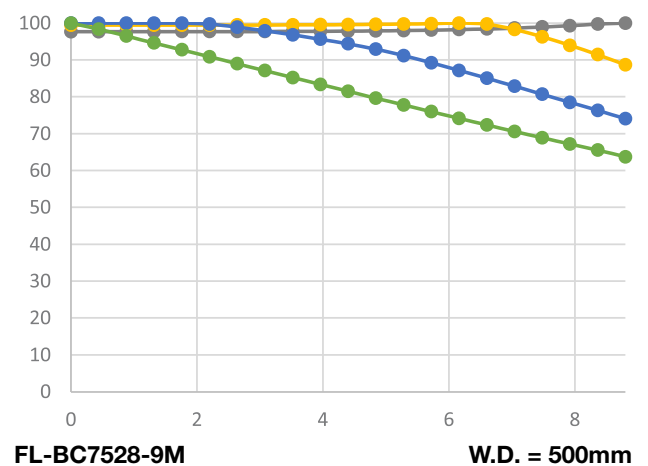
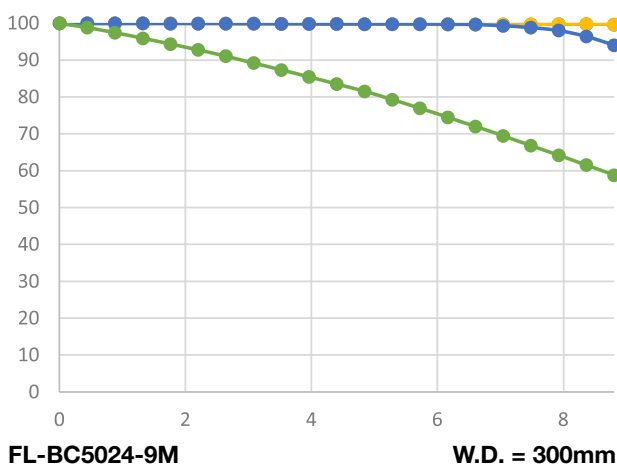
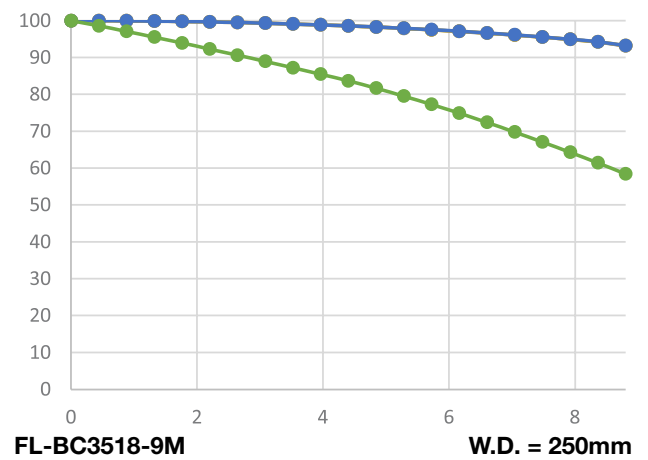
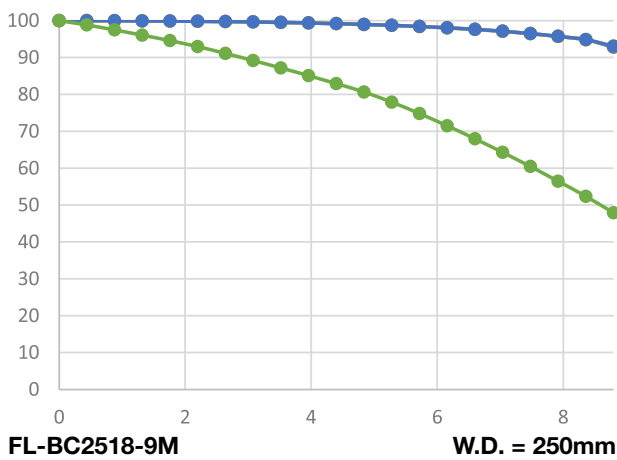
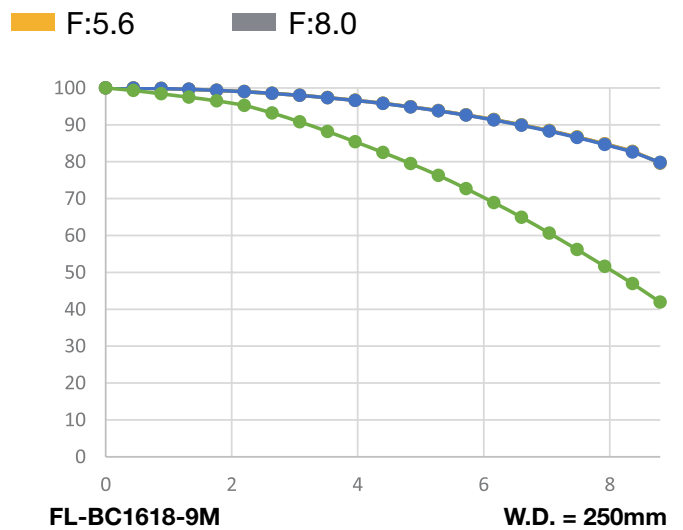
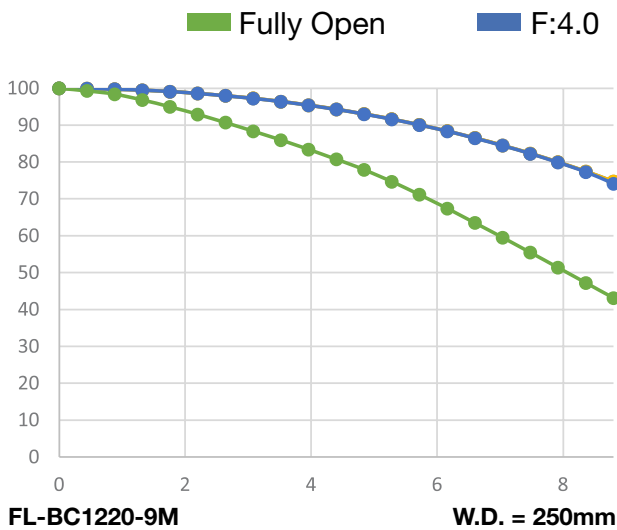

W.D. = Working Distance

# 9 MEGAPIXEL (12 MEGAPIXEL 1.1") LENSES, FIXED FOCAL LENGTH

## Manual Iris, with Locking Screws

Part No.	Format size	Mount	Focal length (mm)	Iris range	Min. Pixel Pitch ( $\mu\text{m}$ )*	M. O. D. (m)	Horizontal angle of view	Filter size (mm)	Dimensions (mm)	Price (Euro)
<b>HIGH-RESOLUTION, FOR STANDARD, IP AND MEGAPIXEL CAMERAS</b>										
FL-BC1220-9M	1" (1.1")	C	12	2.0 - 16	3.45	0.08	57.0°/61.8°	40.5	$\text{Ø}42.0 \times 60.5$	549.00
FL-BC1618-9M	1" (1.1")	C	16	1.8 - 16	3.45	0.08	43.8°/47.7°	40.5	$\text{Ø}42.0 \times 64.0$	549.00
FL-BC2518-9M	1" (1.1")	C	25	1.8 - 16	3.45	0.1	28.8°/31.5°	40.5	$\text{Ø}42.0 \times 57.5$	519.00
FL-BC3518-9M	1" (1.1")	C	35	1.8 - 22	3.45	0.15	20.7°/22.7°	40.5	$\text{Ø}42.0 \times 60.5$	519.00
FL-BC5024-9M	1" (1.1")	C	50	2.4 - 22	3.45	0.2	14.6°/16.0°	40.5	$\text{Ø}42.0 \times 69.0$	559.00
FL-BC7528-9M	1" (1.1")	C	75	2.8 - 32	3.45	0.25	9.8°/10.7°	40.5	$\text{Ø}42.0 \times 81.0$	559.00

\* Min. Pixel Pitch at 30% contrast (measuring on the edge of the Optic)

Unit: mm

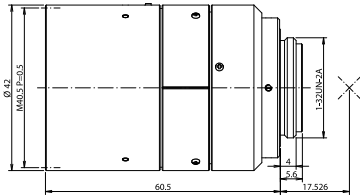

FL-BC1220-9M

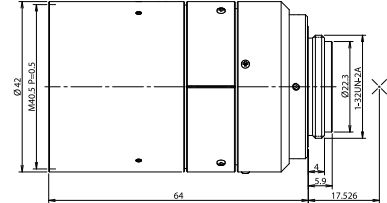

FL-BC1618-9M

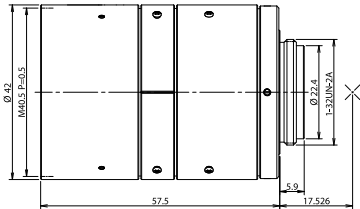

FL-BC2518-9M

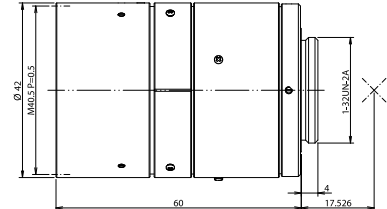

FL-BC3518-9M

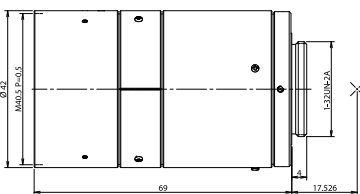

FL-BC5024-9M

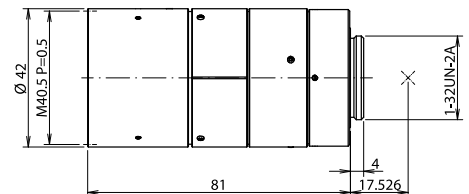

FL-BC7528-9M

## 2 MEGAPIXEL LENSES, SET, BOXED with Tool Set

Part No.	Designation	Specials	Price (Euro)
C99202	BVS-4.2	7x 2 Megapixel Lenses, boxed with tool set FL-HC0614-2M FL-HC1214-2M FL-CC1614-2M FL-CC2514-2M FL-CC3516-2M FL-CC5028-2M FL-CC7528-2M	1,339.00
<b>Accessories:</b>			
C99007	WS-1 tool kit: Screw driver blades + tool holder		
FP-RGST	Extension tube set matt black (anti-reflective), 6 pieces with 0.5 mm, 1.0 mm, 5.0 mm, 10.0 mm, 20.0 mm, 40.0 mm		
C98001IS-1	RP-2 Cleaning pen for lenses with brush and wiper		



Part No.	Designation	Specials	Price (Euro)
C99201	BVS-5	8x 2 Megapixel Lenses, boxed with tool set FL-CC0614A-2M FL-CC0814A-2M FL-CC1214A-2M FL-CC1614A-2M FL-CC2514A-2M FL-CC3516-2M FL-CC5024A-2M FL-CC7528-2M	1,521.00
<b>Accessories:</b>			
C99007	WS-1 tool kit: Screw driver blades + tool holder		
FP-RGST	Extension tube set matt black (anti-reflective), 6 pieces with 0.5 mm, 1.0 mm, 5.0 mm, 10.0 mm, 20.0 mm, 40.0 mm		
C98001IS-1	RP-2 Cleaning pen for lenses with brush and wiper		



## 9 MEGAPIXEL (12 MEGAPIXEL 1.1") LENSES, SET, BOXED with Tool Set

Part No.	Designation	Specials	Price (Euro)
C99204	BVS-6.2	6x 9 Megapixel (12 Megapixel 1.1") Lenses, boxed with tool set FL-BC1220-9M FL-BC1618-9M FL-BC2518-9M FL-BC3518-9M FL-BC5024-9M FL-BC7528-9M	2,999.00
<b>Accessories:</b>			
C99007	WS-1 tool kit: Screw driver blades + tool holder		
FP-RGST	Extension tube set matt black (anti-reflective), 6 pieces with 0.5 mm, 1.0 mm, 5.0 mm, 10.0 mm, 20.0 mm, 40.0 mm		



# LINE-SCAN LENSES UP TO 45 MM

Even, high definition optical characteristics across the entire image (including the periphery). With a design optimized for FA close-up shooting, this lens is suitable for sensors up to 45 mm.

Used for inspection of steel, pulp, fibre/textile, printing, film and other flat materials and Web appearance testing equipment.

- High resolution, high contrast
- Suitable for sensors up to 45 mm
- Abundant Light Distribution
- Minimal distortion
- Available in F-mount
- Lockable focus & iris rings

## Working distance

The working distance is the distance between the object and front end of the lens.

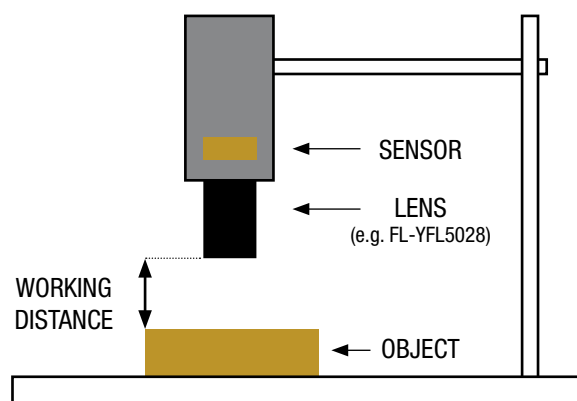

## LINE-SCAN LENSES

### Format 45 mm, Locking Screw for Focus

Part No.	Format size	Mount	Focal length (mm)	Iris range	Min. Pixel Pitch ( $\mu\text{m}$ )*	Working distance (m)	Horizontal angle of view	Filter size (mm)	Dimensions (mm)	Price (Euro)
FL-YFL3528	45mm	F	35	2.8 - 22	5.83	0.19 - $\infty$	64.40°	62	$\varnothing 72.0 \times 56.8$	739.00
FL-YFL5028	45mm	F	50	2.8 - 22	5.83	0.25 - $\infty$	47.60°	62	$\varnothing 72.0 \times 57.8$	739.00

\* Min. Pixel Pitch at 30% contrast (measuring on the edge of the Optic)

Unit: mm

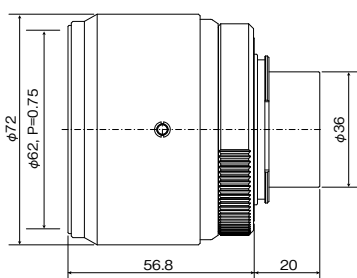

FL-YFL3528

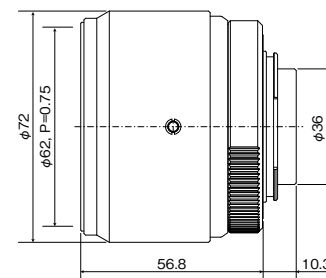

FL-YFL5028

# HIGH PERFORMANCE UV LENSES

An optical system that employs optical-grade quartz glass for imaging in the near-ultraviolet region. This lens is optimized for application in the inspection of minute surfaces. Used for detection of counterfeit banknotes; falsified documents and credit cards, surface inspection of circuit boards for soldering defects.

- High performance quartz glass, enabling the capture of sharp images in the near-ultraviolet region
- Extended wavelength range (230 nm to 800 nm), with peak performance at 365 nm
- Compact design, ideal for integration into machine vision systems
- Optimised for use with band pass filters and UV illumination to provide falsified documents detection

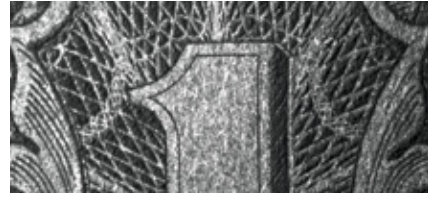

UV Lens with near UV light. The texture of material and unevenness of ink can be recognized

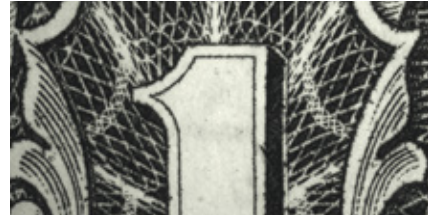

Ordinary Lens with visible light

Part No.	Format size	Mount	Focal length (mm)	Iris range	Min. Pixel Pitch (μm)*	M. O. D. (m)	Horizontal angle of view	Filter size (mm)	Dimensions (mm)	Price (Euro)
FL-BC2528-VGUV	1"	C	25	2.8 - 16	35.00	0.23	29.7°	25.5	Ø30.0 × 25.4	1,199.00
FL-BC7838-VGUV	1"	C	78	3.8 - 16	17.50	0.44	9.5°	49.0	Ø62.5 × 109.3	3,099.00

\* Min. Pixel Pitch at 30% contrast (measuring on the edge of the Optic)

Unit: mm

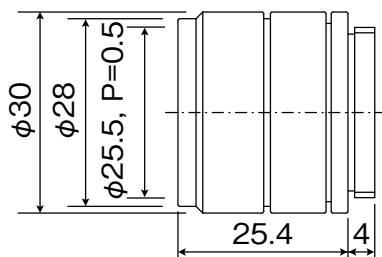

FL-BC2528-VGUV

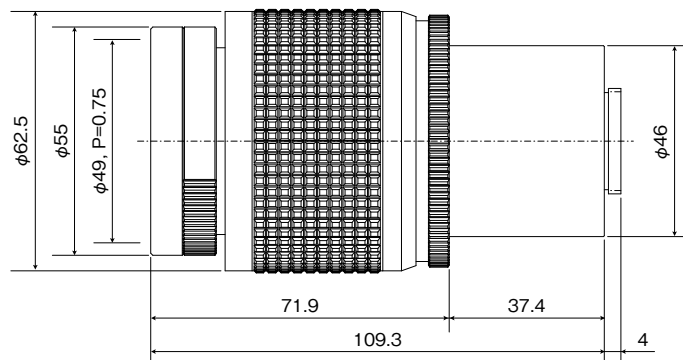

FL-BC7838-VGUV

# 6X ZOOM LENSES MANUAL

## Manual zoom

Part No.	Format size	Mount	Focal length (mm)	Iris range	Min. Pixel Pitch (μm)*	M. O. D. (m)	Horizontal angle of view	Filter size (mm)	Dimensions (mm)	Price (Euro)
① FL-HC6Z0810-VG	1/2"	C	8.0 - 48	1.0 - 22	11.67	0.75	43.3° - 7.7°	55	Ø57 × 95	480.00
FL-CC6Z1218-VG	2/3"	C	12.5 - 75	1.8 - 22	12.25	1.00	38.8° - 6.7°	49	Ø51 × 90	444.00
① FL-CC6Z1218A-VG	2/3"	C	12.5 - 75	1.8 - 22	12.25	1.00	38.8° - 6.7°	49	Ø51 × 90	521.00

\* Min. Pixel Pitch at 30% contrast (measuring on the edge of the Optic), ① Locking Screws

Unit: mm

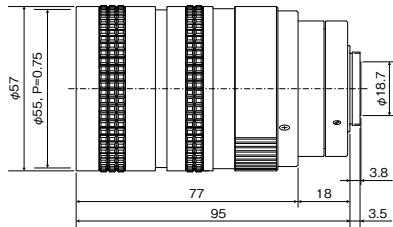

FL-HC6Z0810-VG

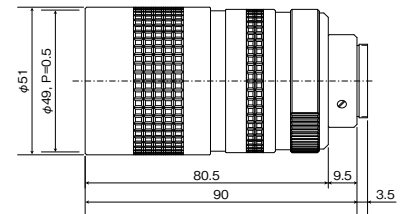

FL-CC6Z1218-VG

FL-CC6Z1218A-VG



# Machine Vision Accessories



Pictures not true to scale

- Focal Length Extender
- Adaptors
- Macro Reversing Ring and Extension Tubes
- Colour, Polarising and UV Blocking Filters



## ACCESSORIES

### Focal Length Extender, Adaptors, Tools

Part No.	Description	Specials	Price (Euro)
<b>FOCAL LENGTH EXTENDER</b>			
FP-EX2	2x, for C-Mount lenses $\varnothing$ 30.5 mm	compact	83.50

Part No.	Description	Specials	Price (Euro)
<b>ADAPTORS</b>			
FP-MA	C-CS-Mount Adaptor		7.00
C99930	Adaptor to connect 2 C-Mount lenses		21.00

Part No.	Designation	Description	Specials	Price (Euro)
<b>TOOLS</b>				
C99007	WS-1	Tool kit, screw driver blades Slot and cross slot + tool holder		19.90
C98001IS-1	RP-2	Cleaning pen for lenses with brush and wiper		7.50



FP-EX2



FP-MA



C99930

## ACCESSORIES

### for close-up applications

Part No.	Description	Filter size (mm)	Specials	Price (Euro)
<b>MACRO REVERSING RING</b>				
FP-RR27	Macro Reversing Ring	27.0		24.00
C80037	RR-40.5 Macro Reversing Ring	40.5		24.00



FP-RR27

# ACCESSORIES

## for close-up applications

Part No.	Description	Specials	Price (Euro)
<b>EXTENSION TUBES</b>			
FP-RGZ5	Extension tube Min. order quantity = 10 pcs	0.5 mm matt black (anti-reflective)	Price per Item 2.50
FP-RG01	Extension tube Min. order quantity = 10 pcs	1.0 mm matt black (anti-reflective)	Price per Item 2.50
FP-MA	Extension tube	5.0 mm	7.00
FP-RG05	Extension tube	5.0 mm matt black (anti-reflective)	13.00
FP-RG10	Extension tube	10.0 mm matt black (anti-reflective)	17.00
FP-RG20	Extension tube	20.0 mm matt black (anti-reflective)	20.00
FP-RG40	Extension tube	40.0 mm matt black (anti-reflective)	33.00
FP-RGST	Extension tube set (6 pieces) Contents: 0.5 mm / 1.0 mm / 5.0 mm / 10.0 mm / 20.0 mm / 40.0 mm		44.00

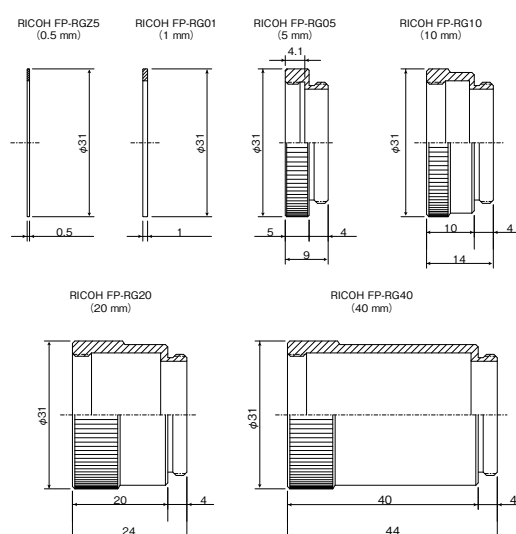

Part No.	Description	Specials	Price (Euro)
<b>MACRO FOCUS MOUNT</b>			
FP-MU2M	Macro Focus Mount - 2mm for FL-HC1214-2M, FL-CC1614-2M, FL-CC2514-2M, FL-CC3516-2M, FL-CC5028-2M		37.00

The Macro Focus Mount is a special camera mount incorporating a 2 mm tube extension. The C-Mount flange focal distance will then be extended by 2 mm to 19.526 mm which will in turn reduce the lenses minimum object distance (M.O.D.).

In order to use our Macro Focus Mount, remove the standard C-mount on the lens and replace it with the mount above.

FP-MU2M is designed for all the machine vision lenses except the FL-HC0614-2M and FL-CC7528-2M. In order to achieve even higher magnifications you can also use the close up adaptors and extension tubes.



FP-MU2M

## ACCESSORIES

### Polarising Filters

Part No.	Designation	Filter size (mm)	Specials	Price (Euro)
C99914	PL/25.5	25.5	linear	28.00
C91309	PL/27	27.0	linear	28.00
C91353	PL/30.5	30.5	linear	28.00
C91301	PL/40.5	40.5	linear	28.00
C91302	PL/43	43.0	linear	28.00
C91303	PL/46	46.0	linear	29.00
C91304	PL/49	49.0	linear	29.00
C91305	PL/52	52.0	linear	33.00
C91300	PL/55	55.0	linear	34.00
C91306	PL/58	58.0	linear	37.00

Other special filters and filter sizes are available upon request



C91309



C91304

### UV Blocking Filters

Part No.	Designation	Filter size (mm)	Price (Euro)
C91109	UV/27	27.0	21.00
C91120	UV/30.5	30.5	21.00
C91101	UV/40.5	40.5	21.00
C91102	UV/43	43.0	21.00
C91103	UV/46	46.0	22.00
C91105	UV/52	52.0	28.00
C91121	UV/55	55.0	28.00
C91106	UV/58	58.0	28.00
C91107	UV/62	62.0	37.00

Other special filters and filter sizes are available upon request

# ACCESSORIES

## Colour Filters

Part No.	Designation	Colour	Filter size (mm)	Price (Euro)
C91319-1	CL/27 (R2)	red	27.0	21.00
C91319-5	CL/27 (Y2)	yellow	27.0	21.00
C99925	CL/30,5 (P01)	green	30.5	21.00

Other special filters and filter sizes are available upon request



# TECHNICAL INFORMATION

## Angle of View

The angle of view is the area shown on screen. The angle is determined by the lens's focal length and the corresponding sensor format.

→ see conversion table on page 36

## Back Focal Length

Back focal length is the distance from the camera's lens flange to the sensor. In CCTV there are two different standards of lens mount commonly used, **C-Mount which has a back focal length of 17.526 mm** and **CS-Mount which has 12.5 mm**.

→ see C-/CS-Mount

## Binning

In binning mode the charge of adjacent pixels is combined as one signal, horizontally, vertically or in both dimensions. Binning reduces the effective resolution of the camera, but achieves an increased sensitivity and signal-noise ratio by combining the pixel's information. Binning is often used for low light applications.

## C-/CS-Mount

The C and CS mount connection is a one inch thread with a specification 1-32UN-2A or B or W 1 inch x 32 TPI (TPI = Thread per inch) and almost corresponds with the metric thread M 25.5 x 0.75 mm.

The angle of light projection for the one inch thread is 55°. However, the metric thread is 60°. By using a C/CS Mount adapter, C mount lenses can be used on CS mount cameras, but it's not possible to use a CS mount lens on a C mount camera.

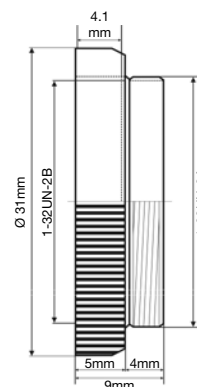

## Camera Interfaces

Usually, industrial cameras transmit images to a PC. Necessary interfaces and protocols are Analog, FireWire, Camera Link™, Gigabit Ethernet™, USB 2.0/3.0.

Ricoh supports the interfaces Camera Link™ and GigE Vision™.

→ See also Camera Link™ and → Gigabit Ethernet & GigE Vision™

## Camera Link™

Camera Link™ is a high-end interface with very high data transfer rates. It is the standard of the Automated Imaging Association (AIA), in which renowned camera, frame grabber and software manufacturers of industrial image processing are united.

### Advantages:

- Very high data transfer rates

### Disadvantages:

- Additional components are necessary (e. g. frame grabber)
- System not interchangeable

## Camera Modes

→ see *Partial-Scan* and → *Binning*

## CCD and CMOS Sensor

The basic function of CCD and CMOS image sensors in the camera is the conversion of light (photons) to electrical signals (electrons).

### CCD Sensor

CCD sensors are light-sensitive electronic modules that are based on the internal photoelectric effect. All CCDs consist of an array (field) of light-sensitive photodiodes. CCD is the abbreviation of Charge Coupled Device, which is used in the CCD sensor. In a CCD, the charges are gradually shifted into registers and then read out.

In addition to CCDs, CMOS sensors are increasingly being used, as the CCD's disadvantages (noise, lower sensitivity) are minimized.

### CMOS Sensor

In a CMOS sensor, the conversion of light to electrons is done by electronic components which are located directly on the pixels. Thus, they can be read directly instead of out of the register as with the CCD sensor.

Characteristics of CMOS sensors such as light sensitivity, number of pixels, readout speed, chip size, noise or the noise related to the dynamic range have been improved significantly and are equal or better than those of CCD sensors. CMOS sensors are more compact, cheaper and with much lower power consumption.

## Coatings (anti-reflection coatings)

High-quality coatings reduce the scattering of light inside the optics of a lens. Reflections inside the optic cause a series of undesired effects:

- For pictures with a high intensity of illumination (e.g. due to the light source itself or sun light), nebular, spot-like reflections and ghost images are being generated.

With nebular reflections, low-contrast images can no longer be displayed due to the loss of contrast.

- With CCD sensors, single bright reflexes lead to phantom images which can pass over the whole picture. Punctual overloading will lead to the typical "smear" effect on the CCD sensor.

Another very important detail is the abrasion resistance of the coating. After each cleaning of the lens surface, the coating should neither be rubbed off or its thickness be changed. Only extensive pre-treatment of the glass surfaces guarantees a long life-time of the razor-thin coating.

## Colour correction

Lenses where red and blue spectral components have been corrected are called achromatic lenses. When they are additionally corrected for green light, they are called apochromatic lenses. And when they are corrected for RGB and near infrared, they are called **superachromatic lenses**.

## Distortion

It is one of the properties of lenses to produce more distortion towards the image border. Straight lines close to the image border are bent outwards or inwards (distorted). Barrel distortion is when the lines are bowed outwards and pin cushion distortion when the lines are bowed inwards (see figures below). In general, a lens with lower distortion is of a higher quality than a lens with higher distortion.

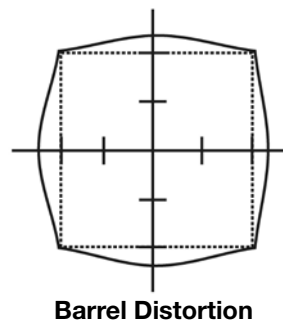
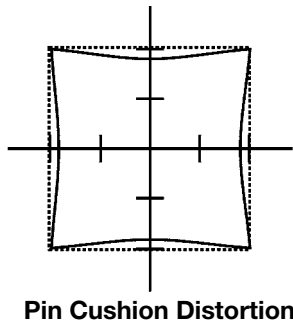

## Entocentric Lenses

Most of the lenses in the machine vision field are entocentric lenses. Here, lenses with fixed focal length (fixed angle of view) and zoom lenses (variable angle of view) are based on the same optical principle and match the perspective of a human eye. An angle of view of about 50° corresponds to the human eye, therefore, lenses with such an angle of view are called standard lenses. Based on the angle of view, lenses can be divided into different classes.

Entocentric lenses are used in many applications – including quantity checks, pick & place applications, print inspection, colour and barcode reading.

Lens Class	Angle of View
Tele Lens	less than 20 degrees
Lens with long focal length	20 to 40 degrees
Standard lens	40 to 55 degrees
Wide angle lens	more than 55 degrees
Super Wide Angle	approx. 110 degrees
Fisheye Lens	approx. 180 degrees

## Filter

### UV cut filter

UV cut filters block UV-light from entering the lens, but allow visible and IR light to pass through. Often UV filters are used to protect the valuable front glass element of lenses.

### Polarising filter

Polarising filters are used to eliminate reflections coming from windows, water etc. The filter is attached to the front end of a lens and rotated until it blocks the unwanted reflection.

### Colour Filter

Colour filters let only a certain colour (= rays with a certain wavelength) pass through to the imaging sensor. For example, only red light passes a red filter. Colour filters are used to emphasize certain details of an image or to reduce disturbances.

## Focal Length (f)

The focal length of an optical system is the distance between the focal point and the related principal plane (or principle point). An imaging system has two principle planes and thereby two focal lengths. Both focal lengths are equal, when a medium with the same refractive index is located on both sides of the imaging system. In a thin lens, both principle planes coincide in the center of the lens. In this case, the focal length is equal to the distance of the focal points to the center of the lens.

## Focus

Setting up the focusing of a lens is always more accurate when it is done with the iris open and the depth of field at its minimum.

## Focus Shift

Light with shorter wavelengths are generally more refracted than light with longer wavelengths. That means, visible light (about 380 nm to 780 nm wavelength) is more refracted than IR light (780 nm to 1400 nm).

## Format 1/3", 1/2", 2/3", 1", 4/3"

Format determines the image circle of a lens that covers the size of the corresponding sensor in a camera. The sizes are given in inches, as image sensors replaced video tubes from the past whose dimensions were specified in inches.

Lenses with a larger format can be used on cameras with smaller image sensors without restriction but not vice versa, as otherwise shading appears in the corners. However, when using a 2/3" lens on a 1/3" camera the specified angle of view for the lens changes.

→ see conversion table on page 36

Whilst in the past sensor sizes in cameras have become increasingly smaller, the current trend is towards large sizes of 1" and 4/3", because the pixels are larger.

## Frame Rate

The frame frequency or frame rate (fps = frames per second, f/sec) indicates the maximum number of unique consecutive images a camera can produce. The frame rate is, inter alia, depending on the exposure time. Very high frame rates can be achieved with CMOS sensors, since their pixels are not read out by registers but by electronic components which are located directly on the pixels, unlike to CCD sensors.

## Gigabit Ethernet & GigE Vision™

GigE Vision™ is a new standard in the industrial image processing market. It defines the hardware standard of the widespread Gigabit Ethernet interface, as well as the software standard for the communication protocol. The so-called GenCam interface (generic programming interface for all kinds of cameras) allows a cross-vendor standard and access to the functionalities of the devices and is part of the GigE Vision™ standard. Proprietary solutions are avoided.

### Benefits of GigE Vision™:

- High data transfer rates of 100 MB/s
- Usability of existing Ethernet infrastructures
- Cable length up to 100 m
- High degree of standardisation by Gigabit Ethernet and GigE Vision™ standards
- Use of hardware technologies from the mass production (controller chips, network devices, switches, cables, connectors, ...)

## High Resolution

Lenses are determined to be of high resolution if they can display a larger number of line pairs per millimeter at higher contrast than standard lenses (measured against the current standard / → see also resolution MTF). High-resolution lenses reproduce images more accurately than standard lenses. In particular, even with low level illumination high-contrast images are still generated.

## Image Format

For monitors and cameras, there is a distinction between different image formats. The well-known VGA format has a size of 640 x 480 pixels. Thereby, the aspect ratio between horizontal and vertical axis is 4:3. Other formats are 4:3 **XGA** (1024 x 768) and **UXGA** (1600 x 1200). The most common 16:9 formats are **HD 720** (1280 x 720) and **HD 1080** (1920 x 1080).

## Image Frequency

→ see Frame Rate



## Image Sensor

→ see *CCD Sensor and CMOS Sensor*

## Iris (F)

The iris reduces the amount of light, which passes through the lens, by reducing the aperture. The mechanical control of the aperture is achieved by a circular arrangement of a number of overlapping slats, which change the aperture's size.

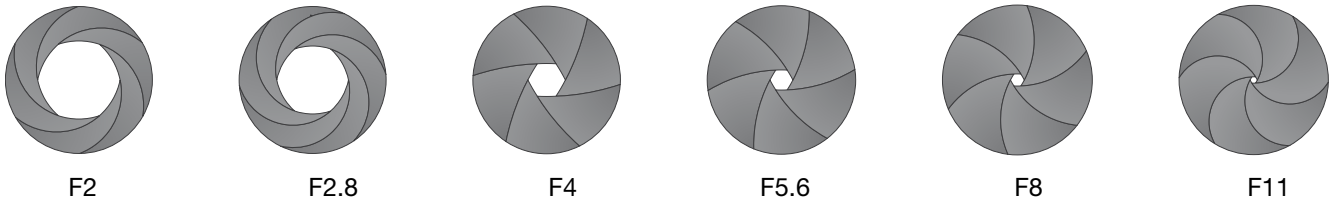

In contrast, the shutter of a MV camera changes the sensor readout time electronically and thus controls the time of exposure (see shutter). By separate settings of illumination, iris and sensor readout time, it is possible, to use the effect of different apertures. By cutting off the peripheral rays when closing the iris (= larger F-No.) certain lens errors are reduced and the depth of field increases.

$$k = \frac{f}{D}$$

The size of the aperture (k) is calculated by taking the focal length ratio (f) and divide it by the diameter of the iris opening (D).

Aperture values are international standards. The aperture levels change at a factor of  $\sqrt{2}$ . On the below chart, from one aperture rating to the next, the amount of light doubles or halves, depending on which direction you are going. So, from an aperture of F8 to F16 the quantity of light will reduce to one quarter.

### Large aperture (fast)

0.7 | 1 | 1.4 | 2 | 2.8 | 4 | 5.6 | 8 | 11 | 16 | 22 | ... | 360 | 512 | 720 | 1000 | 1500 | 2000 | 3000

### Small aperture (slow)

A common iris range is F1.4 - F360, which means that with the iris fully open it is operating at F1.4 and with it closed down as far as possible (and the use of the built in neutral density filter) the aperture is F360.

## Macro Focus Mount (FP-MUVG, FP-MU2M)

The Macro Focus Mount is a special camera mount with a 2 mm tube extension. The C-Mount back focal length will be extended by 2 mm to 19.526 mm which will in turn reduce the lenses minimum object distance (MOD). In order to use our Macro Focus Mount, remove the standard C-mount on the lens and replace with the appropriate mount above. Please ensure you use the correct mount for the lens. In order to achieve even higher magnifications you can also use the close up adaptors and extension tubes.

## MOD (Minimum Object Distance)

The minimum object distance refers to the minimum distance from the front of the lens that an item will remain in focus. To reduce a lens's MOD you can install extension tubes and spacers between the lens and the camera which moves the lens further away from the CCD. The further the lens is from the CCD the closer the MOD. Please note reducing the MOD of a lens in this way affects focus at longer distances.

## MTF (Modulation Transfer Function)

→ See *Resolution*

## OTF (Optical Transfer Function)

→ See Resolution

### Partial Scan

Partial scan allows only a portion of the image sensor to be read. This can either be a freely chosen image detail or an image strip that is a half, quarter or eighth of the image.

Since the size of a partial image is smaller, the camera can capture more images per second, without exceeding the maximum data transfer rate of the camera.

Partial scan is more difficult with CCD sensors, since each entire sensor row is read and thus omission of pixels on the left and right side in a row provide no speed advantage.

CMOS cameras are not affected by these restrictions, since each pixel is surrounded by its own signal transducer and thus a fast readout is possible. **Pixel size and pixel pitch**

The pixel pitch is the direct distance between the pixels of an image sensor or monitor, measured from pixel center to pixel center. Pixel pitch is not the same as the pixel size.

The pixel size can be different for the same size sensors with identical number of pixels as the pixel pitch varies.

### Protrusion

Some C-mount lenses protrude deep into the camera flange. Therefore, it is possible that a lens touches with the front surface of the glass filter in the camera, or even cannot be screwed in. 3-CCD cameras often require lenses with a maximum rear protrusion of 4.0 mm. The prism block in front of the CCD prevents the use of lenses with larger protrusions.

## Resolution (modulation transfer function)

Resolution refers to the distinctness of fine structures. Using a test chart with line pairs per millimeter which get increasingly closer together, the contrast of a lens can be measured.

In the image of the test chart structures with increasing fineness and located closer to the edges of the image become "blurred". The highest optical performance of a lens is usually in the center of the image. The finest structures, which are just discernible, indicate the resolution limit of each lens.

Indicating the brightness of white with 100% and of pitch-black with 0%, the contrast and difference in brightness with increasing line pair density becomes smaller.

The optical performance of an optical system is shown in a diagram, the MTF curve (modulation transfer function). In that diagram, structure fineness (lp / mm = line pairs per mm) can be read in relation to the given contrast from the optical center to the edges.

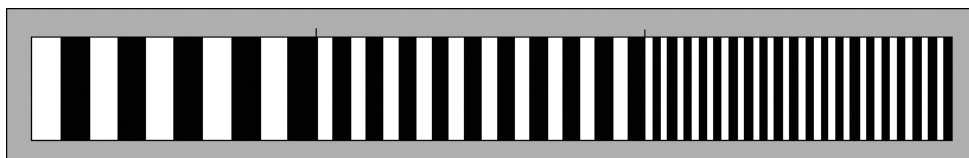

### Reversing ring (for microscopy)

A reverse ring screws to the front filter of a corresponding lens and allows it to attach to the camera in reverse. This creates an extremely short MOD and allows the lens to focus only millimetres from an object. An additional extension tube allows an even closer approximation to the object. The realisable magnifications are of high quality and brightness.

## Shutter

In photography the "Shutter" is, figuratively speaking, a flap, which regulates the exposure time of an image. For video cameras, a mechanical shutter is not appropriate, because it is too slow and would have a high grade of wear. Thus, video cameras have an electronic shutter.

A distinction is made between **global shutter** and **rolling shutter**.

CCD sensors always have a global shutter, in which the entire sensor is exposed. Most CMOS sensors have a rolling shutter, which exposes the sensor line by line. Recently, there are also CMOS sensors with a global shutter.

### Global Shutter

With a global shutter, deletion and subsequent exposure of all sensor lines is simultaneous. At the end of the exposure all data from each row is moved simultaneously to the end. From here the reading of each line is then performed separately.

The simultaneous exposure of all lines has the advantage that the image of a moving object is reproduced without distortion. Sensors working with the global shutter method, however, are more complex than sensors with a rolling shutter.

### Rolling Shutter

With a rolling shutter, deletion and subsequent exposure of the sensor takes place line by line slightly delayed. At the end of the exposure, the lines are read successively. As a result, a time lag occurs between the exposure of the first and the last sensor line, the image of a moving object is distorted.

## Telecentric Lenses

Telecentric lenses are usually used for measurement tasks, because they can measure objects in changing positions without distorting the perspective.

With telecentric lenses, the angle of view is virtually zero degrees within a certain zone (telecentric zone). Hence, the light path is almost parallel and the image is without perspective error. Each object will appear at the same size regardless of their distance. In spatial structures, such as holes, the sides are not seen because the lens looks straight down the hole!

The diameter of the front lens of a telecentric lenses must be at least as large as the object.

## Transmission

Transmission indicates the amount of light, which reaches the sensor after passing through a lens. Typically, the transmission is specified for a wavelength range from 300 nm to 1200 nm (light is visible for the human eye between about 380 nm and 780 nm). The transmission range is from 0% (no light transmission) up to almost 100% (maximum light transmission).

## Trigger Functions (Trigger modes)

Machine vision applications usually work with triggered image recording. Since industrial cameras have no mechanical shutter for exposure control, the sensor is exposed continuously. In order to limit this ongoing exposure a trigger function is used.

- With a hardware trigger, triggering is caused by an external impulse, such as a light barrier.
- With a software trigger, the trigger signal is software controlled.

Standard trigger modes in camera technology are **pulse width trigger** (pulse width control) and the **edge preset trigger** (edge default). For both trigger modes the camera starts the exposure at the rising edge of the trigger signal, and terminates at the falling edge. The term "edge" denotes the change of a digital signal, i.e. the transition from low to high (rising edge) or high to low (falling edge).

The exposure time with an edge width trigger is additionally controlled by a value set in the camera.

## **Types of Lenses**

→ See *Entocentric and Telecentric Lenses*

## **Vignetting (decrease of ambient light)**

Vignetting is a reduction of brightness and/or saturation at the edges of an image compared to the center. It is caused by mechanical (artificial) or physical (natural) effects. By closing the iris, vignetting can be reduced.

# CONVERSION TABLE FOR HORIZONTAL ANGLE OF VIEW

Lenses can be used on cameras with a smaller sensor, but not vice versa. By doing this, the viewing angle will change according to the table below.

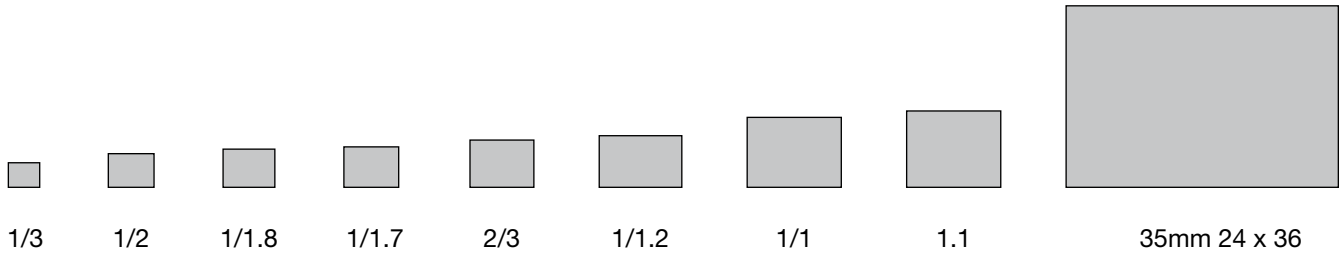

## Horizontal Angle Of View

Format	1/3	1/2	1/1.8	1/1.7	2/3	1/1.2	1/1	1.1	35mm 24 x 36 <sup>1</sup>
<b>Sensor (mm)</b>									
Horizontal	4.8	6.4	7.2	7.5	8.8	11.3	12.8	14.2	36.0
Vertical	3.6	4.8	5.4	5.6	6.6	7.1	9.6	10.4	24.0
Diagonal	6.0	8.0	9.0	9.3	11.0	13.4	16.0	17.6	43.3
<b>Focal Length (mm)</b>									
4.2	64.3°	86.8°							154.0°
4.8	54.6°	71.6°	79.8°	81.3°	96.4°				150.0°
6.0	44.5°	57.4°	61.9°	64.7°	72.5°				143.0°
8.0	33.6°	44.0°	49.0°	49.9°	58.5°				132.1°
8.5	31.9°	42.1°	47.0°	48.2°	56.5°				129.4°
12.0	22.7°	30.0°	33.6°	34.6°	40.6°	51.2°	57.0°	61.8°	112.6°
12.5	22.0°	29.1°	32.6°	33.8°	39.6°	50.3°	55.9°		110.4°
16.0	17.1°	22.7°	25.4°	26.3°	30.8°	39.3°	43.8°	47.7°	96.7°
25.0	11.0°	14.6°	16.4°	17.0°	20.0°	25.6°	28.8°	31.5°	71.5°
35.0	7.8°	10.4°	11.7°	12.2°	14.3°	18.4°	20.7°	22.7°	54.4°
48.0	5.8°	7.7°							41.1°
50.0	5.5°	7.3°	8.2°	8.6°	10.1°	13.0°	14.6°	16.0°	39.6°
75.0	3.7°	4.9°	5.5°	5.7°	6.7°	8.7°	9.8°	10.7°	27.0°
78.0	3.5°	4.7°	5.3°	5.5°	6.5°	8.3°	9.4°		26.0°

Angles of view in this table are calculated. Individual lens angles of view may vary according to optical design. / <sup>1</sup> Indication only

# 5 MX LENS FIELD OF VIEW TABLE BY WORKING DISTANCE

## 2/3"

V: 7.09 mm  
H: 8.5 mm

W.D.	FL-CC0820-5MX	FL-CC1218-5MX	FL-CC1618-5MX	FL-CC2518-5MX	FL-CC3524-5MX
	f = 8mm F2.0	f = 12mm F1.8	f = 16mm F1.8	f = 25mm F1.8	f = 35mm F2.4
	V x H (mm)	V x H (mm)	V x H (mm)	V x H (mm)	V x H (mm)
100	96.0 × 115.1	65.4 × 78.4	50.8 × 60.9	25.8 × 30.9	20.0 × 24.0
125	118.2 × 141.8	80.2 × 96.2	62.0 × 74.3	32.9 × 39.9	25.1 × 30.0
150	140.4 × 168.3	95.1 × 114.0	73.2 × 87.7	40.0 × 48.0	30.1 × 36.1
175	162.5 × 194.9	109.9 × 131.8	84.3 × 101.1	47.1 × 56.5	35.2 × 42.2
200	184.7 × 221.5	124.7 × 149.5	95.5 × 114.5	54.2 × 65.0	40.2 × 48.2
225	206.8 × 248.0	139.5 × 167.3	106.6 × 127.8	61.3 × 73.5	45.3 × 54.3
250	229.0 × 274.5	154.3 × 185.0	117.7 × 141.1	68.4 × 82.0	50.4 × 60.3
275	251.2 × 301.1	169.1 × 202.7	128.8 × 154.4	75.5 × 90.5	55.4 × 66.4
300	273.2 × 327.6	183.9 × 220.4	140.0 × 167.8	82.6 × 99.0	60.5 × 72.4
350	317.5 × 380.7	213.5 × 256.0	162.1 × 194.3	96.7 × 116.0	70.6 × 84.5
400	361.7 × 433.7	243.1 × 291.4	184.3 × 221.0	110.9 × 133.0	80.7 × 96.7
450	406.1 × 486.8	272.5 × 326.8	206.6 × 247.6	125.1 × 150.0	90.8 × 108.8
500	450.4 × 540.0	302.2 × 362.3	228.7 × 274.2	139.3 × 167.0	100.9 × 120.9

## 1/1.8"

V: 5.4 mm  
H: 7.2 mm

W.D.	FL-CC0820-5MX	FL-CC1218-5MX	FL-CC1618-5MX	FL-CC2518-5MX	FL-CC3524-5MX
	f = 8mm F2.0	f = 12mm F1.8	f = 16mm F1.8	f = 25mm F1.8	f = 35mm F2.4
	V x H (mm)	V x H (mm)	V x H (mm)	V x H (mm)	V x H (mm)
100	73.2 × 97.5	49.8 × 66.4	38.7 × 51.6	19.6 × 26.2	15.3 × 20.3
125	90.1 × 120.1	61.1 × 81.5	47.2 × 63.0	25.0 × 33.4	19.1 × 25.5
150	106.9 × 142.6	72.4 × 96.6	55.7 × 74.3	30.5 × 40.6	23.0 × 30.6
175	123.8 × 165.1	83.7 × 111.6	64.2 × 85.6	35.9 × 47.8	26.8 × 35.7
200	140.7 × 187.6	95.0 × 126.6	72.7 × 96.9	41.3 × 55.0	30.7 × 40.9
225	157.5 × 210.0	106.3 × 141.7	81.2 × 108.3	46.7 × 62.2	34.5 × 46.0
250	174.4 × 232.6	117.5 × 156.7	89.7 × 119.5	52.1 × 69.5	38.4 × 51.1
275	191.3 × 255.0	128.8 × 171.7	98.1 × 130.8	57.5 × 76.7	42.2 × 56.3
300	208.1 × 277.5	140.0 × 186.7	106.6 × 142.1	62.9 × 83.9	46.1 × 61.4
350	241.8 × 322.4	162.6 × 216.8	123.5 × 164.6	73.7 × 98.3	53.8 × 71.7
400	275.5 × 367.3	185.1 × 246.8	140.4 × 187.2	84.5 × 112.7	61.5 × 81.9
450	309.3 × 412.4	207.6 × 276.8	157.3 × 209.7	95.1 × 127.1	69.2 × 92.2
500	343.1 × 457.4	230.2 × 306.9	174.2 × 232.3	106.1 × 141.5	76.9 × 102.5

## 1/2"

V: 4.8 mm  
H: 6.4 mm

W.D.	FL-CC0820-5MX	FL-CC1218-5MX	FL-CC1618-5MX	FL-CC2518-5MX	FL-CC3524-5MX
	f = 8mm F2.0	f = 12mm F1.8	f = 16mm F1.8	f = 25mm F1.8	f = 35mm F2.4
	V x H (mm)	V x H (mm)	V x H (mm)	V x H (mm)	V x H (mm)
100	65.0 × 86.7	44.3 × 59.0	34.4 × 45.8	17.5 × 23.3	13.6 × 18.1
125	80.1 × 106.7	54.3 × 72.4	42.0 × 56.0	22.3 × 29.7	17.0 × 22.6
150	95.0 × 126.7	64.4 × 85.8	49.5 × 66.1	27.1 × 36.1	20.4 × 27.2
175	110.0 × 146.7	74.4 × 99.2	57.1 × 76.1	31.9 × 42.5	23.8 × 31.8
200	125.1 × 166.8	84.4 × 112.6	64.6 × 86.2	36.7 × 48.9	27.3 × 36.3
225	140.0 × 186.7	94.5 × 125.9	72.2 × 96.2	41.5 × 55.3	30.7 × 40.9
250	155.0 × 206.7	104.5 × 139.3	79.7 × 106.3	46.3 × 61.7	34.1 × 45.5
275	170.0 × 226.7	114.5 × 152.6	87.2 × 116.3	51.1 × 68.1	37.5 × 50.0
300	185.0 × 246.6	124.5 × 166.0	94.7 × 126.3	55.9 × 74.5	41.0 × 54.6
350	215.0 × 286.6	144.5 × 192.7	109.8 × 146.4	65.5 × 87.3	47.8 × 63.7
400	244.9 × 326.5	164.6 × 219.4	124.8 × 166.4	75.1 × 100.1	54.7 × 72.8
450	274.9 × 366.6	184.5 × 246.1	139.8 × 186.4	84.7 × 112.9	61.5 × 82.0
500	305.0 × 406.6	204.6 × 272.8	154.8 × 206.5	94.3 × 125.7	68.4 × 91.1

## 9 MP (1") LENS FIELD OF VIEW TABLE BY WORKING DISTANCE

V: 9.6 mm

H: 12.8 mm

W.D.	FL-BC1220-9M	FL-BC1618-9M	FL-BC2518-9M	FL-BC3518-9M	FL-BC5024-9M	FL-BC7528-9M
	f = 12mm F2.0	f = 16mm F1.8	f = 25mm F1.8	f = 35mm F1.8	f = 50mm F2.4	f = 75mm F2.8
	V x H (mm)	V x H (mm)	V x H (mm)	V x H (mm)	V x H (mm)	V x H (mm)
80	72.6 × 96.8	56.5 × 75.4	-	-	-	-
100	88.7 × 118.3	68.6 × 91.5	39.1 × 52.2	-	-	-
125	108.8 × 145.0	83.7 × 111.6	48.7 × 65.0	-	-	-
150	128.8 × 171.7	98.8 × 131.7	58.3 × 77.8	38.4 × 51.1	-	-
175	148.8 × 198.4	113.8 × 151.7	67.9 × 90.6	45.2 × 60.3	-	-
200	168.8 × 225.1	128.8 × 171.8	77.5 × 103.4	52.1 × 69.4	36.4 × 48.6	-
225	188.8 × 251.7	143.8 × 191.8	87.1 × 116.2	58.9 × 78.6	41.2 × 55.0	-
250	208.7 × 278.3	158.9 × 211.8	96.8 × 129.0	65.8 × 87.7	46.0 × 61.4	26.5 × 35.3
275	228.7 × 305.0	173.9 × 231.8	106.4 × 141.8	72.7 × 96.9	50.8 × 67.8	29.7 × 39.5
300	248.7 × 331.6	188.9 × 251.8	116.0 × 154.6	79.5 × 106.0	55.6 × 74.2	32.9 × 43.8
350	288.6 × 384.8	218.9 × 291.8	135.2 × 180.2	93.2 × 124.3	65.2 × 87.0	39.3 × 52.3
400	328.5 × 438.1	248.9 × 331.9	154.4 × 205.8	106.9 × 142.6	74.8 × 99.8	45.7 × 60.9
450	368.5 × 491.4	278.9 × 371.9	173.6 × 231.4	120.7 × 160.9	84.4 × 112.6	52.1 × 69.4
500	408.5 × 544.7	308.9 × 411.8	192.8 × 257.0	134.4 × 179.2	94.1 × 125.4	58.5 × 77.9

## 12 MP (1.1") LENS FIELD OF VIEW TABLE BY WORKING DISTANCE

V: 10.56 mm

H: 14.08 mm

W.D.	FL-BC1220-9M	FL-BC1618-9M	FL-BC2518-9M	FL-BC3518-9M	FL-BC5024-9M	FL-BC7528-9M
	f = 12mm F2.0	f = 16mm F1.8	f = 25mm F1.8	f = 35mm F1.8	f = 50mm F2.4	f = 75mm F2.8
	V x H (mm)	V x H (mm)	V x H (mm)	V x H (mm)	V x H (mm)	V x H (mm)
80	79.9 × 106.5	62.2 × 82.9	-	-	-	-
100	97.6 × 130.1	75.5 × 100.7	43.0 × 57.4	-	-	-
125	119.6 × 159.5	92.1 × 122.8	53.6 × 71.5	-	-	-
150	141.7 × 188.9	108.6 × 144.9	64.2 × 85.6	42.2 × 56.3	-	-
175	163.7 × 218.2	125.2 × 166.9	74.7 × 99.6	49.7 × 66.3	-	-
200	185.7 × 247.6	141.7 × 188.9	85.3 × 113.7	57.3 × 76.4	40.1 × 53.5	-
225	207.7 × 276.9	158.2 × 211.0	95.9 × 127.8	64.8 × 86.4	45.4 × 60.5	-
250	229.6 × 306.2	174.7 × 233.0	106.4 × 141.9	72.4 × 96.5	50.6 × 67.5	29.1 × 38.8
275	251.6 × 335.5	191.3 × 255.0	117.0 × 156.0	79.9 × 106.6	55.9 × 74.6	32.6 × 43.5
300	273.6 × 364.8	207.8 × 277.0	127.6 × 170.1	87.5 × 116.6	61.2 × 81.6	36.1 × 48.2
350	317.5 × 423.3	240.8 × 321.0	148.7 × 198.3	102.6 × 136.7	71.8 × 95.7	43.2 × 57.6
400	361.4 × 481.9	273.8 × 365.1	169.8 × 226.4	117.6 × 156.8	82.3 × 109.8	50.2 × 67.0
450	405.4 × 540.5	306.8 × 409.1	190.9 × 254.6	132.7 × 177.0	92.9 × 123.9	57.3 × 76.4
500	449.4 × 599.1	339.8 × 453.0	212.0 × 282.7	147.8 × 197.1	103.5 × 137.9	64.3 × 85.7

# OPTICAL CALCULATIONS FOR CLOSE-UP APPLICATIONS

When viewing an object measuring 20 mm per side from a working distance (WD) of 100 mm with a 1/2" format camera (6.4 x 4.8 mm, 1.5 mega pixels)

First, calculate the magnification, M, by the following formula:

$$M = -B/A \quad M = -4.8/20 = -0.24 \times$$

(The horizontal screen dimension is automatically decided when the vertical dimension is decided. Therefore, the vertical screen dimension is used here). Obtain a rough idea of the focal length required for your application with the object distance and magnification between the object size and image size by using the following formula:

$$f = -M \times O \quad f = -(-0.24) \times 100 = 24 \text{ mm}$$

According to the calculation a 24 mm lens is required. Then, select one of the closest RICOH lenses to 24 mm: FL-BC2514D-VG, FL-BC2518-VG, FL-CC2514-2M. Since the camera is 1.5 mega pixel, substitute the true focal length of FL-CC2514-2M into the following formula to calculate the overall distance L, by adding up the figures indicated in the attached table.

$$L = -f/M + f + \Delta H - f \times M$$

$$L = -(25.00/(-0.24)) + 25.00 + 25.00 + (-10.51) - (25.00 \times (-0.24))$$

$$L = 104.17 + 25.00 + 25.00 - 10.51 + 6.00 = 149.66$$

Finally, you can get an exact objective distance, O by the following formula:

(f x M is the length of the extension tube)

$$O = L - d + f \times M$$

$$O = 149.66 - 49.53 + (25.00 \times (-0.24)) = 94.13$$

Therefore, when viewing an object measuring 20 mm per side on a 1/2" format camera, use the FL-CC2514-2M and extension tube of 6 mm in length with a WD of 94.13 (about 94 mm). Use a lens with a longer f (focal length) if you want a longer WD, or a lens with a shorter focal length if you want a shorter WD.

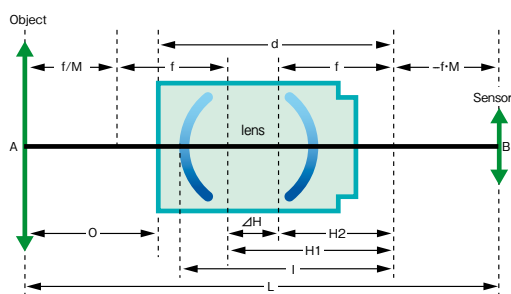

A	Object size (Vertical or Horizontal)
B	Imager format size (Vertical or Horizontal)
M	Magnification (B/A)
f	Focal length
H1	1st principal position
H2	2nd principal position
ΔH	Distance between 1st and 2nd principal position
d	Distance between the front end of lens barrel and the focal point
l	Distance between the 1st lens element and the focal point
f-M	Length of the extension tube
O	Object distance (Distance between the front end of lens barrel and the object)

Model name	Focal Length (f)	1 <sup>st</sup> Principal Position (H1)	2 <sup>nd</sup> Principal Position (H2)	Distance between H1 and H2 (ΔH)	Optical Path Length (l)	Total Length (d)	Entrance Pupil Position	Diameter of Entrance Pupil	Exit Pupil Position	Diameter of Exit Pupil Position	Distortion in %	Back Focal Length (in air)	Remarks
<b>9 Megapixel 1" / 12 Megapixel 1.1" Lenses</b>													
FL-BC1220-9M	12.0	-49.8	-12.0	37.7	75.3	78.0	-59.5	5.8	-61.5	30.8	-2.1 -2.1	14.1	W.D. = 250mm <sup>1</sup>
FL-BC1618-9M	16.0	-47.0	-16.0	31.0	78.2	81.5	-58.0	8.7	-51.0	28.7	-0.5 -0.5	14.1	W.D. = 250mm <sup>1</sup>
FL-BC2518-9M	25.0	-32.0	-25.0	7.0	61.5	75.0	-42.5	13.5	-43.0	24.2	-0.5 -0.5	14.1	W.D. = 250mm <sup>1</sup>
FL-BC3518-9M	35.0	-29.2	-35.0	-5.8	57.9	77.5	-38.6	19.0	-47.9	27.0	0.1 0.1	16.8	W.D. = 250mm <sup>1</sup>
FL-BC5024-9M	50.0	-36.9	-50.0	-13.1	71.2	86.5	-44.2	20.4	-58.4	24.4	-0.3 -0.3	18.8	W.D. = 300mm <sup>1</sup>
FL-BC7528-9M	75.0	-47.3	-75.0	-27.7	82.6	98.5	-24.7	26.1	-57.6	20.3	-0.1 -0.2	21.3	W.D. = 500mm <sup>1</sup>
<b>Exceeding 5 Megapixel Lenses</b>													
FL-CC0820-5MX	8.0	-40.1	-8.0	32.1	57.9	60.1	-46.7	3.9	-45.1	22.6	-2.2	13.0	W.D. = 250mm <sup>1</sup>
FL-CC1218-5MX	12.0	-35.4	-12.0	23.4	59.3	64.5	-44.6	6.5	-52.3	29.6	-0.5	13.2	W.D. = 250mm <sup>1</sup>
FL-CC1618-5MX	16.0	-29.3	-16.0	13.3	59.7	64.5	-40.1	8.7	-48.7	27.6	-0.5	13.4	W.D. = 250mm <sup>1</sup>
FL-CC2518-5MX	25.0	-19.6	-25.2	-5.6	40.4	67.5	-26.0	13.5	-33.9	18.2	-0.1	13.7	W.D. = 250mm <sup>1</sup>
FL-CC3524-5MX	35.0	-17.6	-35.0	-17.4	59.5	65.5	-35.8	14.2	-58.77	29.6	0.3	14.3	W.D. = 250mm <sup>1</sup>
<b>5 Megapixel Lenses</b>													
FL-CC0814-5M	8.2	-49.9	-8.2	41.7	77.7	81.5	-57.1	5.8	-64.2	48.0	-4.9	11.5	W.D. = 250mm
FL-CC1614-5M	16.0	-29.6	-16.0	13.6	58.9	64.5	-40.9	11.2	-54.3	40.5	-0.5	11.5	W.D. = 250mm
FL-CC2514-5M	25.0	-9.8	-25.0	-15.2	47.6	61.5	-22.4	17.5	-50.2	37.6	-1.0	12.3	W.D. = 250mm
<b>2 Megapixel (A) (2/3") Lenses</b>													
FL-CC0614A-2M	6.2	-51.7	-6.2	45.5	73.9	77.4	-57.6	4.3	-123.5	92.4	-1.3	10.9	W.D. = 250mm
FL-CC0814A-2M	8.2	-30.3	-8.2	22.0	51.5	54.2	-38.1	5.7	-171.7	127.6	-1.0	11.1	W.D. = 250mm
FL-CC1214A-2M	12.3	-32.4	-12.3	20.1	58.8	63.2	-42.9	8.4	-86.9	63.5	-0.5	10.7	W.D. = 250mm
FL-CC1614A-2M	16.0	-16.2	-16.0	0.2	43.4	49.7	-29.4	11.2	-90.3	67.3	-0.5	10.7	W.D. = 250mm
FL-CC2514A-2M	25.6	-12.9	-25.6	-12.7	39.9	55.5	-17.0	17.9	-30.4	22.7	-1.1	12.1	W.D. = 250mm
FL-CC5024A-2M	48.8	-39.5	-48.8	-9.3	51.8	64.0	-4.2	19.9	-28.3	11.9	0.1	22.3	W.D. = 300mm
<b>2 Megapixel (2/3") Lenses</b>													
FL-CC1614-2M	16.0	-18.0	-16.0	2.0	46.6	50.7	-30.2	11.2	-68.0	50.7	-2.0	14.6	W.D. = 250mm
FL-CC2514-2M	25.0	-14.5	-25.0	-10.5	39.5	49.5	-19.6	17.5	-31.4	23.5	-1.2	11.5	W.D. = 250mm
FL-CC3516-2M	34.0	-10.9	-34.0	-23.0	47.1	52.9	-11.3	20.6	-34.3	22.0	-0.9	11.9	W.D. = 250mm
FL-CC5028-2M	50.0	-47.4	-50.0	-2.6	46.5	51.5	-3.2	17.9	-26.5	9.7	-0.1	21.0	W.D. = 250mm
FL-CC7528-2M	72.8	-57.4	-72.8	-15.4	72.8	77.1	16.1	25.2	-36.2	12.8	0.0	30.9	W.D. = 250mm
<b>2 Megapixel (1/2") Lenses</b>													
FL-HC0614-2M	6.0	-35.2	-6.0	29.2	42.0	55.0	-39.5	4.3	-21.8	30.7	-2.9	12.4	W.D. = 225mm
FL-HC1214-2M	12.4	-17.8	-12.4	5.4	41.0	46.0	-25.8	8.6	-34.5	25.7	-0.7	11.5	W.D. = 250mm
<b>VGA (1") Lenses</b>													
FL-BC1214D-VG	12.7	-34.3	-12.7	21.7	63.5	67.5	-42.9	8.6	-39.5	28.5	-1.7	14.4	W.D. = Inf.
FL-BC1218A-VG	12.4	-24.6	-12.4	12.2	39.5	57.5	-31.8	6.8	-29.8	16.9	-3.9	10.4	W.D. = Inf.
FL-BC2514D-VG	25.1	-25.6	-25.1	0.5	51.4	54.8	-30.3	17.5	-30.8	22.7	-2.8	15.0	W.D. = Inf.
FL-BC2518-VG	25.0	-22.1	-25.0	-2.9	31.1	57.5	-15.6	13.9	-19.9	11.4	1.4	14.9	W.D. = Inf.
FL-BC5014A-VG	49.9	-47.3	-49.9	-2.6	57.4	65.5	1.7	35.7	-25.2	19.3	0.9	18.1	W.D. = Inf.
<b>VGA (2/3") Lenses</b>													
FL-CC0418DX-VG	4.9	-37.0	-4.9	32.1	51.6	53.0	-41.5	2.8	-54.9	31.8	-28.8	9.7	W.D. = Inf.
FL-CC0815B-VG	8.5	-31.2	-8.5	22.6	53.6	57.5	-39.1	5.7	-115.2	80.8	-4.2	10.9	W.D. = Inf.
FL-CC1614A-VG	16.2	-20.1	-16.2	3.9	41.0	50.5	-30.5	11.6	-45.7	34.9	-1.9	13.2	W.D. = Inf.
<b>VGA (1/2") Lenses</b>													
FL-HC0416X-VG	4.3	-42.2	-4.3	37.8	59.5	61.0	-46.1	2.7	-43.5	27.7	-35.8	10.4	W.D. = Inf.
FL-HC0612A-VG	6.2	-39.0	-6.2	32.8	58.3	63.5	-44.9	5.0	-111.4	97.8	-5.8	14.3	W.D. = Inf.
FL-HC1212B-VG	12.2	-26.7	-12.2	14.5	47.6	53.0	-38.5	10.0	-322.6	289.7	-4.3	13.9	W.D. = Inf.
<b>Line Scan Lenses</b>													
FL-YFL3528	36.3	-61.8	-36.3	25.5	89.9	103.3	-72.3	13.0	-51.0	18.5	-0.5	33.2	M = -0.2 <sup>1</sup>
FL-YFL5028	52.0	-54.8	-52.0	2.8	71.1	103.3	-57.1	18.6	-54.5	19.8	0.2	37.0	M = -0.2 <sup>1</sup>
<b>UV Lenses</b>													
FL-BC2528-VGUV	25.0	-24.9	-25.0	-0.2	34.9	42.9	-25.9	8.9	-26.1	9.3	-4.1	12.8	266nm
FL-BC7838-VGUV	77.5	-77.6	-77.5	0.1	96.8	126.8	-78.8	20.4	-78.8	20.7	-0.2	71.3	250nm

\*1 These models adopt a floating mechanism and are not covered by the calculation above. Please contact us for details.

Unit: mm



# 2 MEGAPIXEL LENS + MACRO RING – 2/3" FORMAT

W.D. (Working Distance): Object-L1 vertex

V: 6.6 H: 8.8	2/3" FORMAT	FL-CC0614A-2M			FL-CC0814A-2M			FL-CC1214A-2M			FL-CC1614A-2M			FL-CC1614A-2M			FL-CC2514-2M									
		f=6mm F1.4			f=8mm F1.4			f=12mm F1.4			f=16mm F1.4			f=16mm F1.4			f=25mm F1.4									
		Position of Focus Ring	V x H (mm)	W.D.	V x H (mm)	W.D.	V x H (mm)	W.D.	V x H (mm)	W.D.	V x H (mm)	W.D.	V x H (mm)	W.D.	V x H (mm)	W.D.	V x H (mm)	W.D.	V x H (mm)	W.D.						
0.5mm	maximum	81.8 x 109.1	61	108.8 x 145.1	123	162.3 x 216.4	288	211.2 x 281.6	499	211.3 x 281.7	501	330.0 x 440.1	1250	minimum	49.2 x 65.6	30	49.4 x 65.8	49	44.5 x 59.3	69	71.6 x 95.5	161	37.7 x 50.2	80	55.0 x 73.3	208
	maximum	40.9 x 54.5	22	54.4 x 72.5	55	81.1 x 108.2	137	105.6 x 140.8	243	105.6 x 140.9	245	165.0 x 220.0	625	minimum	30.7 x 41.0	13	34.0 x 45.3	29	34.9 x 46.5	51	53.5 x 71.3	117	32.0 x 42.6	66	47.1 x 62.9	179
1.5mm (1+0.5)	maximum	X	-	36.3 x 48.4	32	54.1 x 72.1	87	70.4 x 93.9	158	70.4 x 93.9	160	110.0 x 146.7	417	minimum	X	-	25.9 x 34.5	19	28.7 x 38.3	39	42.7 x 56.9	91	27.8 x 37.0	56	41.2 x 55.0	156
	maximum	X	-	X	-	16.2 x 21.6	16	21.1 x 28.2	39	21.1 x 28.2	40	33.0 x 44.0	125	minimum	X	-	X	-	12.8 x 17.1	10	17.7 x 23.6	30	14.5 x 19.3	24	22.0 x 29.3	83
5mm	maximum	X	-	X	-	X	-	10.6 x 14.1	13	10.6 x 14.1	14	16.5 x 22.0	63	minimum	X	-	X	-	X	-	9.6 x 12.8	11	8.6 x 11.4	10	13.2 x 17.6	50
	maximum	X	-	X	-	X	-	X	-	X	-	11.0 x 14.7	42	minimum	X	-	X	-	X	-	X	-	X	-	9.4 x 12.6	36
10mm	maximum	X	-	X	-	X	-	X	-	X	-	8.3 x 11.0	31	minimum	X	-	X	-	X	-	X	-	X	-	7.3 x 9.8	28
	maximum	X	-	X	-	X	-	X	-	X	-	6.6 x 8.8	25	minimum	X	-	X	-	X	-	X	-	X	-	6.0 x 8.0	23
20mm	maximum	X	-	X	-	X	-	X	-	X	-	5.5 x 7.3	21	minimum	X	-	X	-	X	-	X	-	X	-	5.1 x 6.8	19
	maximum	X	-	X	-	X	-	X	-	X	-	4.7 x 6.3	18	minimum	X	-	X	-	X	-	X	-	X	-	4.4 x 5.9	17
25mm (20+5)	maximum	X	-	X	-	X	-	X	-	X	-	4.1 x 5.5	16	minimum	X	-	X	-	X	-	X	-	X	-	3.9 x 5.2	15
	maximum	X	-	X	-	X	-	X	-	X	-	3.7 x 4.9	14	minimum	X	-	X	-	X	-	X	-	X	-	3.5 x 4.6	13
30mm (20+10)	maximum	X	-	X	-	X	-	X	-	X	-	3.3 x 4.4	13	minimum	X	-	X	-	X	-	X	-	X	-	3.1 x 4.2	12
	maximum	X	-	X	-	X	-	X	-	X	-	3.1 x 4.2	12	minimum	X	-	X	-	X	-	X	-	X	-	3.1 x 4.2	12

Extension Tube Set (Macro Ring) FP-RGST (0.5mm, 1mm, 5mm, 10mm, 20mm and 40mm)

# 2 MEGAPIXEL LENS + MACRO RING – 2/3" FORMAT

W.D. (Working Distance): Object→L1 vertex

2/3" FORMAT		FL-CC2514A-2M	FL-CC3516-2M	FL-CC5028-2M	FL-CC5024A-2M	FL-CC7528-2M					
V: 6.6 H: 8.8	Position of Focus Ring	f=25mm F1.4		f=50mm F2.8		f=75mm F2.8					
		V x H (mm)	W.D.	V x H (mm)	W.D.	V x H (mm)	W.D.				
0.5mm	maximum	338.2 x 451.0	1312	448.1 x 597.5	2303	659.8 x 879.7	5048	643.5 x 858.0	4790	960.8 x 1281.0	10652
	minimum	24.2 x 32.3	93	66.6 x 88.8	340	95.8 x 127.8	777	33.8 x 45.1	286	54.9 x 73.3	663
1.0mm	maximum	169.1 x 225.5	655	224.1 x 298.8	1150	329.9 x 439.9	2549	321.8 x 429.0	2413	480.4 x 640.5	5355
	minimum	22.6 x 30.1	86	58.0 x 77.3	296	83.7 x 111.6	685	32.1 x 42.8	274	52.0 x 69.3	630
1.5mm (1+0.5)	maximum	112.7 x 150.3	436	149.4 x 199.2	766	219.9 x 293.2	1716	214.5 x 286.0	1621	320.3 x 427.0	3589
	minimum	21.2 x 28.3	81	51.3 x 68.4	262	74.3 x 99.0	613	30.6 x 40.8	262	49.3 x 65.7	601
5mm	maximum	33.8 x 45.1	130	44.8 x 59.8	228	66.0 x 88.0	551	64.4 x 85.8	512	96.1 x 128.1	1117
	minimum	14.7 x 19.6	56	28.5 x 38.0	144	41.5 x 55.4	365	23.0 x 30.6	206	36.3 x 48.4	457
10mm	maximum	16.9 x 22.5	64	22.4 x 29.9	113	33.0 x 44.0	301	32.2 x 42.9	274	48.0 x 64.1	587
	minimum	10.3 x 13.7	39	17.4 x 23.2	87	25.5 x 34.0	244	16.9 x 22.6	161	26.3 x 35.1	348
15mm (10+5)	maximum	11.3 x 15.0	42	14.9 x 19.9	75	22.0 x 29.3	217	21.5 x 28.6	195	32.0 x 42.7	411
	minimum	7.9 x 10.5	29	12.5 x 16.7	62	18.4 x 24.5	190	13.4 x 17.9	135	20.7 x 27.6	285
20mm	maximum	8.5 x 11.3	32	11.2 x 14.9	55	16.5 x 22.0	176	16.1 x 21.5	155	24.0 x 32.0	322
	minimum	6.4 x 8.5	23	9.8 x 13.1	48	14.4 x 19.2	160	11.1 x 14.8	118	17.0 x 22.7	245
25mm (20+5)	maximum	6.8 x 9.0	25	9.0 x 12.0	44	13.2 x 17.6	151	12.9 x 17.2	132	19.2 x 25.6	269
	minimum	5.4 x 7.2	20	8.0 x 10.7	39	11.8 x 15.7	140	9.5 x 12.6	106	14.5 x 19.3	217
30mm (20+10)	maximum	5.6 x 7.5	21	7.5 x 10.0	36	11.0 x 14.7	134	10.7 x 14.3	116	16.0 x 21.4	234
	minimum	4.6 x 6.2	17	6.8 x 9.1	33	10.0 x 13.4	127	8.2 x 11.0	97	12.6 x 16.7	196
35mm (20+10+5)	maximum	4.8 x 6.4	17	6.4 x 8.5	31	9.4 x 12.6	122	9.2 x 12.3	104	13.7 x 18.3	209
	minimum	4.1 x 5.4	15	5.9 x 7.9	28	8.7 x 11.6	117	7.3 x 9.7	90	11.1 x 14.8	180
40mm	maximum	4.2 x 5.6	15	5.6 x 7.5	27	8.2 x 11.0	113	8.0 x 10.7	96	12.0 x 16.0	190
	minimum	3.6 x 4.9	13	5.2 x 7.0	25	7.7 x 10.2	109	6.6 x 8.8	85	10.0 x 13.3	167
45mm (40+5)	maximum	3.8 x 5.0	13	5.0 x 6.6	23	7.3 x 9.8	106	7.2 x 9.5	89	10.7 x 14.2	175
	minimum	3.3 x 4.4	11	4.7 x 6.2	22	6.9 x 9.2	103	6.0 x 7.9	80	9.0 x 12.0	157
50mm (40+10)	maximum	3.4 x 4.5	12	4.5 x 6.0	21	6.6 x 8.8	101	6.4 x 8.6	84	9.6 x 12.8	163
	minimum	3.0 x 4.0	10	4.2 x 5.7	20	6.2 x 8.3	98	5.5 x 7.3	77	8.2 x 11.0	148

Extension Tube Set (Macro Ring) FP-RGST  
(0.5mm, 1mm, 5mm, 10mm, 20mm and 40mm)

## 2 MEGAPIXEL LENS + MACRO RING – 1/1.8" FORMAT

W.D. (Working Distance): Object~L1 vertex

1/1.8" FORMAT		f=6mm F1.4			f=8mm F1.4			f=12mm F1.4			f=16mm F1.4			f=25mm F1.4											
V: 5.4 H: 7.2	Position of Focus Ring	V x H (mm)		W.D.	V x H (mm)		W.D.	V x H (mm)		W.D.	V x H (mm)		W.D.	V x H (mm)		W.D.									
		0.5mm	maximum	66.9	x	89.3	61	89.0	x	118.7	123	132.8	x	177.0	288	172.8	x	230.4	499	172.9	x	230.5	501	270.0	x
	minimum	40.3	x	53.7	30	40.4	x	53.9	49	36.4	x	48.5	69	58.6	x	78.1	161	30.8	x	41.1	80	45.0	x	60.0	208
1.0mm	maximum	33.5	x	44.6	22	44.5	x	59.3	55	66.4	x	88.5	137	86.4	x	115.2	243	86.4	x	115.3	245	135.0	x	180.0	625
	minimum	25.1	x	33.5	13	27.8	x	37.1	29	28.6	x	38.1	51	43.8	x	58.3	117	26.1	x	34.9	66	38.6	x	51.4	179
1.5mm (1+0.5)	maximum	x		-	-	29.7	x	39.6	32	44.3	x	59.0	87	57.6	x	76.8	158	57.6	x	76.8	160	90.0	x	120.0	417
	minimum	x		-	-	21.2	x	28.2	19	23.5	x	31.3	39	34.9	x	46.5	91	22.7	x	30.3	56	33.7	x	45.0	156
5mm	maximum	x		-	-	-	x	-	-	13.3	x	17.7	16	17.3	x	23.0	39	17.3	x	23.1	40	27.0	x	36.0	125
	minimum	x		-	-	-	x	-	-	10.5	x	14.0	10	14.5	x	19.3	30	11.8	x	15.8	24	18.0	x	24.0	83
10mm	maximum	x		-	-	-	x	-	-	-	x	-	-	8.6	x	11.5	13	8.6	x	11.5	14	13.5	x	18.0	63
	minimum	x		-	-	-	x	-	-	-	x	-	-	7.9	x	10.5	11	7.0	x	9.4	10	10.8	x	14.4	50
15mm (10+5)	maximum	x		-	-	-	x	-	-	-	x	-	-	-	x	-	-	-	x	-	-	-	-	-	42
	minimum	x		-	-	-	x	-	-	-	x	-	-	-	x	-	-	-	x	-	-	-	-	-	36
20mm	maximum	x		-	-	-	x	-	-	-	x	-	-	-	x	-	-	-	x	-	-	-	-	-	31
	minimum	x		-	-	-	x	-	-	-	x	-	-	-	x	-	-	-	x	-	-	-	-	-	28
25mm (20+5)	maximum	x		-	-	-	x	-	-	-	x	-	-	-	x	-	-	-	x	-	-	-	-	-	25
	minimum	x		-	-	-	x	-	-	-	x	-	-	-	x	-	-	-	x	-	-	-	-	-	23
30mm (20+10)	maximum	x		-	-	-	x	-	-	-	x	-	-	-	x	-	-	-	x	-	-	-	-	-	21
	minimum	x		-	-	-	x	-	-	-	x	-	-	-	x	-	-	-	x	-	-	-	-	-	19
35mm (20+10+5)	maximum	x		-	-	-	x	-	-	-	x	-	-	-	x	-	-	-	x	-	-	-	-	-	18
	minimum	x		-	-	-	x	-	-	-	x	-	-	-	x	-	-	-	x	-	-	-	-	-	17
40mm	maximum	x		-	-	-	x	-	-	-	x	-	-	-	x	-	-	-	x	-	-	-	-	-	16
	minimum	x		-	-	-	x	-	-	-	x	-	-	-	x	-	-	-	x	-	-	-	-	-	15
45mm (40+5)	maximum	x		-	-	-	x	-	-	-	x	-	-	-	x	-	-	-	x	-	-	-	-	-	14
	minimum	x		-	-	-	x	-	-	-	x	-	-	-	x	-	-	-	x	-	-	-	-	-	13
50mm (40+10)	maximum	x		-	-	-	x	-	-	-	x	-	-	-	x	-	-	-	x	-	-	-	-	-	13
	minimum	x		-	-	-	x	-	-	-	x	-	-	-	x	-	-	-	x	-	-	-	-	-	12

Extension Tube Set (Macro Ring) FP-RGST (0.5mm, 1mm, 5mm, 10mm, 20mm and 40mm)

# 2 MEGAPIXEL LENS + MACRO RING – 1/1.8" FORMAT

W.D. (Working Distance): Object→L1 vertex

1/1.8" FORMAT		FL-CC2514A-2M		FL-CC3516-2M		FL-CC5028-2M		FL-CC5024A-2M		FL-CC7528-2M	
V: 5.4 H: 7.2	Position of Focus Ring	f=25mm F1.4		f=35mm F1.6		f=50mm F2.8		f=50mm F2.4		f=75mm F2.8	
		V x H (mm)	W.D.	V x H (mm)	W.D.	V x H (mm)	W.D.	V x H (mm)	W.D.	V x H (mm)	W.D.
0.5mm	maximum	276.7 x 369.0	1312	366.7 x 488.9	2303	539.8 x 719.8	5048	526.5 x 702.0	4790	786.1 x 1048.1	10652
	minimum	19.8 x 26.4	93	54.5 x 72.6	340	78.4 x 104.6	777	27.7 x 36.9	286	45.0 x 59.9	663
1.0mm	maximum	138.4 x 184.5	655	183.3 x 244.4	1150	269.9 x 359.9	2549	263.3 x 351.0	2413	393.0 x 524.0	5355
	minimum	18.5 x 24.7	86	47.4 x 63.2	296	68.5 x 91.3	685	26.3 x 35.0	274	42.5 x 56.7	630
1.5mm (1+0.5)	maximum	92.2 x 123.0	436	122.2 x 163.0	766	179.9 x 239.9	1716	175.5 x 234.0	1621	262.0 x 349.4	3589
	minimum	17.3 x 23.1	81	42.0 x 56.0	262	60.8 x 81.0	613	25.0 x 33.4	262	40.3 x 53.8	601
5mm	maximum	27.7 x 36.9	130	36.7 x 48.9	228	54.0 x 72.0	551	52.7 x 70.2	512	78.6 x 104.8	1117
	minimum	12.1 x 16.1	56	23.3 x 31.1	144	34.0 x 45.3	365	18.8 x 25.0	206	29.7 x 39.6	457
10mm	maximum	13.8 x 18.4	64	18.3 x 24.4	113	27.0 x 36.0	301	26.3 x 35.1	274	39.3 x 52.4	587
	minimum	8.4 x 11.2	39	14.2 x 19.0	87	20.9 x 27.8	244	13.8 x 18.5	161	21.5 x 28.7	348
15mm (10+5)	maximum	9.2 x 12.3	42	12.2 x 16.3	75	18.0 x 24.0	217	17.6 x 23.4	195	26.2 x 34.9	411
	minimum	6.4 x 8.6	29	10.3 x 13.7	62	15.0 x 20.1	190	11.0 x 14.6	135	16.9 x 22.5	285
20mm	maximum	6.9 x 9.2	32	9.2 x 12.2	55	13.5 x 18.0	176	13.2 x 17.6	155	19.7 x 26.2	322
	minimum	5.2 x 7.0	23	8.0 x 10.7	48	11.8 x 15.7	160	9.1 x 12.1	118	13.9 x 18.6	245
25mm (20+5)	maximum	5.5 x 7.4	25	7.3 x 9.8	44	10.8 x 14.4	151	10.5 x 14.0	132	15.7 x 21.0	269
	minimum	4.4 x 5.9	20	6.6 x 8.8	39	9.7 x 12.9	140	7.7 x 10.3	106	11.8 x 15.8	217
30mm (20+10)	maximum	4.6 x 6.1	21	6.1 x 8.1	36	9.0 x 12.0	134	8.8 x 11.7	116	13.1 x 17.5	234
	minimum	3.8 x 5.1	17	5.6 x 7.4	33	8.2 x 10.9	127	6.7 x 9.0	97	10.3 x 13.7	196
35mm (20+10+5)	maximum	4.0 x 5.3	17	5.2 x 7.0	31	7.7 x 10.3	122	7.5 x 10.0	104	11.2 x 15.0	209
	minimum	3.3 x 4.4	15	4.8 x 6.5	28	7.1 x 9.5	117	6.0 x 8.0	90	9.1 x 12.1	180
40mm	maximum	3.5 x 4.6	15	4.6 x 6.1	27	6.7 x 9.0	113	6.6 x 8.8	96	9.8 x 13.1	190
	minimum	3.0 x 4.0	13	4.3 x 5.7	25	6.3 x 8.4	109	5.4 x 7.2	85	8.1 x 10.9	167
45mm (40+5)	maximum	3.1 x 4.1	13	4.1 x 5.4	23	6.0 x 8.0	106	5.9 x 7.8	89	8.7 x 11.6	175
	minimum	2.7 x 3.6	11	3.8 x 5.1	22	5.6 x 7.5	103	4.9 x 6.5	80	7.4 x 9.8	157
50mm (40+10)	maximum	2.8 x 3.7	12	3.7 x 4.9	21	5.4 x 7.2	101	5.3 x 7.0	84	7.9 x 10.5	163
	minimum	2.4 x 3.3	10	3.5 x 4.6	20	5.1 x 6.8	98	4.5 x 5.9	77	6.7 x 9.0	148

Extension Tube Set (Macro Ring) FP-RGST  
(0.5mm, 1mm, 5mm, 10mm, 20mm and 40mm)

# 2 MEGAPIXEL LENS + MACRO RING – 1/2" FORMAT

W.D. (Working Distance): Object~L1 vertex

V: 4.8 H: 6.4	1/2" FORMAT	FL-CC0614A-2M			FL-CC0814A-2M			FL-CC1214A-2M			FL-CC1614A-2M			FL-CC1614A-2M			FL-CC2514-2M									
		f=6mm F1.4			f=8mm F1.4			f=12mm F1.4			f=16mm F1.4			f=16mm F1.4			f=25mm F1.4									
		Position of Focus Ring	V x H (mm)	W.D.	V x H (mm)	W.D.	V x H (mm)	W.D.	V x H (mm)	W.D.	V x H (mm)	W.D.	V x H (mm)	W.D.	V x H (mm)	W.D.	V x H (mm)	W.D.	V x H (mm)	W.D.						
0.5mm	maximum	59.5 x 79.3	61	79.1 x 105.5	123	118.0 x 157.4	288	153.6 x 204.8	499	153.7 x 204.9	501	240.0 x 320.0	1250	minimum	35.8 x 47.7	30	35.9 x 47.9	49	32.3 x 43.1	69	52.1 x 69.4	161	27.4 x 36.5	80	40.0 x 53.3	208
	maximum	29.8 x 39.7	22	39.6 x 52.7	55	59.0 x 78.7	137	76.8 x 102.4	243	76.8 x 102.4	245	120.0 x 160.0	625	minimum	22.4 x 29.8	13	24.7 x 32.9	29	25.4 x 33.8	51	38.9 x 51.9	117	23.2 x 31.0	66	34.3 x 45.7	179
1.5mm (1+0.5)	maximum	X	-	26.4 x 35.2	32	39.3 x 52.5	87	51.2 x 68.3	158	51.2 x 68.3	160	80.0 x 106.7	417	minimum	X	-	18.8 x 25.1	19	20.9 x 27.9	39	31.0 x 41.4	91	20.2 x 26.9	56	30.0 x 40.0	156
	maximum	X	-	X	-	11.8 x 15.7	16	15.4 x 20.5	39	15.4 x 20.5	40	24.0 x 32.0	125	minimum	X	-	X	-	9.3 x 12.4	10	12.9 x 17.1	30	10.5 x 14.0	24	16.0 x 21.3	83
5mm	maximum	X	-	X	-	X	-	7.7 x 10.2	13	7.7 x 10.2	14	12.0 x 16.0	63	minimum	X	-	X	-	X	-	7.0 x 9.3	11	6.2 x 8.3	10	9.6 x 12.8	50
	maximum	X	-	X	-	X	-	X	-	X	-	8.0 x 10.7	42	minimum	X	-	X	-	X	-	X	-	X	-	6.9 x 9.1	36
15mm (10+5)	maximum	X	-	X	-	X	-	X	-	X	-	6.0 x 8.0	31	minimum	X	-	X	-	X	-	X	-	X	-	5.3 x 7.1	28
	maximum	X	-	X	-	X	-	X	-	X	-	4.8 x 6.4	25	minimum	X	-	X	-	X	-	X	-	X	-	4.4 x 5.8	23
20mm	maximum	X	-	X	-	X	-	X	-	X	-	4.0 x 5.3	21	minimum	X	-	X	-	X	-	X	-	X	-	3.7 x 4.9	19
	maximum	X	-	X	-	X	-	X	-	X	-	3.4 x 4.6	18	minimum	X	-	X	-	X	-	X	-	X	-	3.2 x 4.3	17
25mm (20+5)	maximum	X	-	X	-	X	-	X	-	X	-	3.0 x 4.0	16	minimum	X	-	X	-	X	-	X	-	X	-	2.8 x 3.8	15
	maximum	X	-	X	-	X	-	X	-	X	-	2.7 x 3.6	14	minimum	X	-	X	-	X	-	X	-	X	-	2.5 x 3.4	13
30mm (20+10)	maximum	X	-	X	-	X	-	X	-	X	-	2.4 x 3.2	13	minimum	X	-	X	-	X	-	X	-	X	-	2.3 x 3.0	12
	maximum	X	-	X	-	X	-	X	-	X	-	2.3 x 3.0	12	minimum	X	-	X	-	X	-	X	-	X	-	2.3 x 3.0	12
35mm (20+10+5)	maximum	X	-	X	-	X	-	X	-	X	-	2.3 x 3.0	12	minimum	X	-	X	-	X	-	X	-	X	-	2.3 x 3.0	12
	maximum	X	-	X	-	X	-	X	-	X	-	2.3 x 3.0	12	minimum	X	-	X	-	X	-	X	-	X	-	2.3 x 3.0	12
40mm	maximum	X	-	X	-	X	-	X	-	X	-	2.3 x 3.0	12	minimum	X	-	X	-	X	-	X	-	X	-	2.3 x 3.0	12
	maximum	X	-	X	-	X	-	X	-	X	-	2.3 x 3.0	12	minimum	X	-	X	-	X	-	X	-	X	-	2.3 x 3.0	12
45mm (40+5)	maximum	X	-	X	-	X	-	X	-	X	-	2.3 x 3.0	12	minimum	X	-	X	-	X	-	X	-	X	-	2.3 x 3.0	12
	maximum	X	-	X	-	X	-	X	-	X	-	2.3 x 3.0	12	minimum	X	-	X	-	X	-	X	-	X	-	2.3 x 3.0	12
50mm (40+10)	maximum	X	-	X	-	X	-	X	-	X	-	2.3 x 3.0	12	minimum	X	-	X	-	X	-	X	-	X	-	2.3 x 3.0	12
	maximum	X	-	X	-	X	-	X	-	X	-	2.3 x 3.0	12	minimum	X	-	X	-	X	-	X	-	X	-	2.3 x 3.0	12

Extension Tube Set (Macro Ring) FP-RGST  
(0.5mm, 1mm, 5mm, 10mm, 20mm and 40mm)

# 2 MEGAPIXEL LENS + MACRO RING – 1/2" FORMAT

W.D. (Working Distance): Object→L1 vertex

1/2" FORMAT		FL-CC2514A-2M	FL-CC3516-2M	FL-CC5028-2M	FL-CC5024A-2M	FL-CC7528-2M					
V: 4.8 H: 6.4	Position of Focus Ring	f=25mm F1.4		f=50mm F2.8		f=75mm F2.8					
		V x H (mm)	W.D.	V x H (mm)	W.D.	V x H (mm)	W.D.				
0.5mm	maximum	246.0 x 328.0	1312	325.9 x 434.6	2303	479.8 x 639.8	5048	468.0 x 624.0	4790	698.7 x 931.6	10652
	minimum	17.6 x 23.5	93	48.4 x 64.5	340	69.7 x 92.9	777	24.6 x 32.8	286	40.0 x 53.3	663
1.0mm	maximum	123.0 x 164.0	655	163.0 x 217.3	1150	239.9 x 319.9	2549	234.0 x 312.0	2413	349.4 x 465.8	5355
	minimum	16.4 x 21.9	86	42.2 x 56.2	296	60.9 x 81.1	685	23.4 x 31.1	274	37.8 x 50.4	630
1.5mm (1+0.5)	maximum	82.0 x 109.3	436	108.6 x 144.9	766	159.9 x 213.3	1716	156.0 x 208.0	1621	232.9 x 310.5	3589
	minimum	15.4 x 20.5	81	37.3 x 49.8	262	54.0 x 72.0	613	22.2 x 29.7	262	35.9 x 47.8	601
5mm	maximum	24.6 x 32.8	130	32.6 x 43.5	228	48.0 x 64.0	551	46.8 x 62.4	512	69.9 x 93.2	1117
	minimum	10.7 x 14.3	56	20.7 x 27.6	144	30.2 x 40.3	365	16.7 x 22.3	206	26.4 x 35.2	457
10mm	maximum	12.3 x 16.4	64	16.3 x 21.7	113	24.0 x 32.0	301	23.4 x 31.2	274	34.9 x 46.6	587
	minimum	7.5 x 10.0	39	12.7 x 16.9	87	18.5 x 24.7	244	12.3 x 16.4	161	19.2 x 25.5	348
15mm (10+5)	maximum	8.2 x 10.9	42	10.9 x 14.5	75	16.0 x 21.3	217	15.6 x 20.8	195	23.3 x 31.1	411
	minimum	5.7 x 7.6	29	9.1 x 12.2	62	13.4 x 17.8	190	9.7 x 13.0	135	15.0 x 20.0	285
20mm	maximum	6.1 x 8.2	32	8.1 x 10.9	55	12.0 x 16.0	176	11.7 x 15.6	155	17.5 x 23.3	322
	minimum	4.6 x 6.2	23	7.1 x 9.5	48	10.5 x 13.9	160	8.1 x 10.8	118	12.4 x 16.5	245
25mm (20+5)	maximum	4.9 x 6.6	25	6.5 x 8.7	44	9.6 x 12.8	151	9.4 x 12.5	132	14.0 x 18.6	269
	minimum	3.9 x 5.2	20	5.8 x 7.8	39	8.6 x 11.4	140	6.9 x 9.2	106	10.5 x 14.0	217
30mm (20+10)	maximum	4.1 x 5.5	21	5.4 x 7.2	36	8.0 x 10.7	134	7.8 x 10.4	116	11.6 x 15.5	234
	minimum	3.4 x 4.5	17	5.0 x 6.6	33	7.3 x 9.7	127	6.0 x 8.0	97	9.1 x 12.2	196
35mm (20+10+5)	maximum	3.5 x 4.7	17	4.7 x 6.2	31	6.9 x 9.1	122	6.7 x 8.9	104	10.0 x 13.3	209
	minimum	3.0 x 4.0	15	4.3 x 5.7	28	6.3 x 8.4	117	5.3 x 7.1	90	8.1 x 10.8	180
40mm	maximum	3.1 x 4.1	15	4.1 x 5.4	27	6.0 x 8.0	113	5.9 x 7.8	96	8.7 x 11.6	190
	minimum	2.6 x 3.5	13	3.8 x 5.1	25	5.6 x 7.4	109	4.8 x 6.4	85	7.2 x 9.7	167
45mm (40+5)	maximum	2.7 x 3.6	13	3.6 x 4.8	23	5.3 x 7.1	106	5.2 x 6.9	89	7.8 x 10.4	175
	minimum	2.4 x 3.2	11	3.4 x 4.5	22	5.0 x 6.7	103	4.3 x 5.8	80	6.6 x 8.7	157
50mm (40+10)	maximum	2.5 x 3.3	12	3.3 x 4.3	21	4.8 x 6.4	101	4.7 x 6.2	84	7.0 x 9.3	163
	minimum	2.2 x 2.9	10	3.1 x 4.1	20	4.5 x 6.0	98	4.0 x 5.3	77	6.0 x 8.0	148

Extension Tube Set (Macro Ring) FP-RGST  
(0.5mm, 1mm, 5mm, 10mm, 20mm and 40mm)

# 5 MEGAPIXEL LENS + MACRO RING – 2/3" FORMAT

W.D. (Working Distance): Object~L1 vertex

		2/3" FORMAT			FL-CC0814-5M			FL-CC1614-5M			FL-CC2514-5M		
V: 6.6 H: 8.8	Position of Focus Ring	f=8mm F1.4			f=16mm F1.4			f=25mm F1.4					
		V x H (mm)	W.D.		V x H (mm)	W.D.		V x H (mm)	W.D.				
<b>Extension Tube Set (Macro Ring) FP-RGST</b> (0.5mm, 1mm, 5mm, 10mm, 20mm and 40mm)	0.5mm	maximum	108.8 x 145.0	116	211.1 x 281.4	498	330.0 x 440.0	1237					
		minimum	50.9 x 67.9	44	38.3 x 51.1	79	27.3 x 36.4	91					
	1.0mm	maximum	54.4 x 72.5	48	105.5 x 140.7	242	165.0 x 220.0	612					
		minimum	34.7 x 46.2	24	32.4 x 43.2	65	25.2 x 33.6	83					
	1.5mm (1+0.5)	maximum	36.3 x 48.3	26	70.4 x 93.8	157	110.0 x 146.7	404					
		minimum	26.3 x 35.1	13	28.1 x 37.5	55	23.4 x 31.2	76					
	5mm	maximum	x	-	21.1 x 28.1	38	33.0 x 44.0	112					
		minimum	x	-	14.5 x 19.4	22	15.7 x 20.9	46					
	10mm	maximum	x	-	10.6 x 14.1	12	16.5 x 22.0	50					
		minimum	x	-	8.6 x 11.5	8	10.6 x 14.2	27					
	15mm (10+5)	maximum	x	-	x	-	11.0 x 14.7	29					
		minimum	x	-	x	-	8.0 x 10.7	18					
	20mm	maximum	x	-	x	-	8.3 x 11.0	18					
		minimum	x	-	x	-	6.5 x 8.6	12					
	25mm (20+5)	maximum	x	-	x	-	6.6 x 8.8	12					
		minimum	x	-	x	-	5.4 x 7.2	8					
	30mm (20+10)	maximum	x	-	x	-	x	-					
		minimum	x	-	x	-	x	-					
35mm (20+10+5)	maximum	x	-	x	-	x	-						
	minimum	x	-	x	-	x	-						
40mm	maximum	x	-	x	-	x	-						
	minimum	x	-	x	-	x	-						
45mm (40+5)	maximum	x	-	x	-	x	-						
	minimum	x	-	x	-	x	-						
50mm (40+10)	maximum	x	-	x	-	x	-						
	minimum	x	-	x	-	x	-						

# 5 MEGAPIXEL LENS + MACRO RING – 1/1.8" FORMAT

W.D. (Working Distance): Object-L1 vertex

1/1.8" FORMAT		FL-CC0814-5M			FL-CC1614-5M			FL-CC2514-5M		
V: 5.4 H: 7.2	Position of Focus Ring	f=8mm F1.4			f=16mm F1.4			f=25mm F1.4		
		V x H (mm)	W.D.		V x H (mm)	W.D.		V x H (mm)	W.D.	
0.5mm	maximum	89.0 x 118.6	116	172.7 x 230.2	498	270.0 x 360.0	1237			
	minimum	41.7 x 55.5	44	31.3 x 41.8	79	22.3 x 29.8	91			
1.0mm	maximum	44.5 x 59.3	48	86.3 x 115.1	242	135.0 x 180.0	612			
	minimum	28.4 x 37.8	24	26.5 x 35.4	65	20.6 x 27.5	83			
1.5mm (1+0.5)	maximum	29.7 x 39.5	26	57.6 x 76.7	157	90.0 x 120.0	404			
	minimum	21.5 x 28.7	13	23.0 x 30.7	55	19.2 x 25.6	76			
5mm	maximum	x	-	17.3 x 23.0	38	27.0 x 36.0	112			
	minimum	x	-	11.9 x 15.9	22	12.8 x 17.1	46			
10mm	maximum	x	-	8.6 x 11.5	12	13.5 x 18.0	50			
	minimum	x	-	7.0 x 9.4	8	8.7 x 11.6	27			
15mm (10+5)	maximum	x	-	x	-	9.0 x 12.0	29			
	minimum	x	-	x	-	6.6 x 8.8	18			
20mm	maximum	x	-	x	-	6.8 x 9.0	18			
	minimum	x	-	x	-	5.3 x 7.0	12			
25mm (20+5)	maximum	x	-	x	-	5.4 x 7.2	12			
	minimum	x	-	x	-	4.4 x 5.9	8			
30mm (20+10)	maximum	x	-	x	-	x	-			
	minimum	x	-	x	-	x	-			
35mm (20+10+5)	maximum	x	-	x	-	x	-			
	minimum	x	-	x	-	x	-			
40mm	maximum	x	-	x	-	x	-			
	minimum	x	-	x	-	x	-			
45mm (40+5)	maximum	x	-	x	-	x	-			
	minimum	x	-	x	-	x	-			
50mm (40+10)	maximum	x	-	x	-	x	-			
	minimum	x	-	x	-	x	-			

Extension Tube Set (Macro Ring) FP-RGST  
(0.5mm, 1mm, 5mm, 10mm, 20mm and 40mm)



# 5 MEGAPIXEL LENS + MACRO RING – 1/2" FORMAT

W.D. (Working Distance): Object~L1 vertex

1/2" FORMAT		FL-CC0814-5M	FL-CC1614-5M	FL-CC2514-5M						
V: 4.8 H: 6.4	Position of Focus Ring	f=8mm F1.4			f=16mm F1.4			f=25mm F1.4		
		V x H (mm)	W.D.	V x H (mm)	W.D.	V x H (mm)	W.D.	V x H (mm)	W.D.	
0.5mm	maximum	79.1 x 105.5	116	153.5 x 204.7	498	240.0 x 320.0	1237			
	minimum	37.0 x 49.4	44	27.9 x 37.1	79	19.9 x 26.5	91			
1.0mm	maximum	39.5 x 52.7	48	76.7 x 102.3	242	120.0 x 160.0	612			
	minimum	25.2 x 33.6	24	23.6 x 31.4	65	18.3 x 24.5	83			
1.5mm (1+0.5)	maximum	26.4 x 35.2	26	51.2 x 68.2	157	80.0 x 106.7	404			
	minimum	19.1 x 25.5	13	20.4 x 27.2	55	17.0 x 22.7	76			
5mm	maximum	x	-	15.3 x 20.5	38	24.0 x 32.0	112			
	minimum	x	-	10.6 x 14.1	22	11.4 x 15.2	46			
10mm	maximum	x	-	7.7 x 10.2	12	12.0 x 16.0	50			
	minimum	x	-	6.3 x 8.3	8	7.7 x 10.3	27			
15mm (10+5)	maximum	x	-	x	-	8.0 x 10.7	29			
	minimum	x	-	x	-	5.8 x 7.8	18			
20mm	maximum	x	-	x	-	6.0 x 8.0	18			
	minimum	x	-	x	-	4.7 x 6.3	12			
25mm (20+5)	maximum	x	-	x	-	4.8 x 6.4	12			
	minimum	x	-	x	-	3.9 x 5.2	8			
30mm (20+10)	maximum	x	-	x	-	x	-			
	minimum	x	-	x	-	x	-			
35mm (20+10+5)	maximum	x	-	x	-	x	-			
	minimum	x	-	x	-	x	-			
40mm	maximum	x	-	x	-	x	-			
	minimum	x	-	x	-	x	-			
45mm (40+5)	maximum	x	-	x	-	x	-			
	minimum	x	-	x	-	x	-			
50mm (40+10)	maximum	x	-	x	-	x	-			
	minimum	x	-	x	-	x	-			

Extension Tube Set (Macro Ring) FP-RGST  
(0.5mm, 1mm, 5mm, 10mm, 20mm and 40mm)

# EXCEEDING 5 MEGAPIXEL LENS + MACRO RING – 2/3" FORMAT

W.D. (Working Distance): Object~L1 vertex

		2/3" FORMAT			FL-CC0820-5MX			FL-CC1218-5MX			FL-CC1618-5MX			FL-CC2518-5MX			FL-CC3524-5MX		
		f=8mm F2.0			f=12mm F1.8			f=16mm F1.8			f=25mm F1.8			f=35mm F2.4					
V: 7.09 H: 8.5	Position of Focus Ring	V x H (mm)	W.D.	V x H (mm)	W.D.	V x H (mm)	W.D.	V x H (mm)	W.D.	V x H (mm)	W.D.	V x H (mm)	W.D.	V x H (mm)	W.D.	V x H (mm)	W.D.		
		0.5mm	∞	113.6 x 136.2	119	170.1 x 203.9	276	226.8 x 271.9	497	354.5 x 425.0	1254	496.3 x 595.0	2467						
minimum	52.2 x 62.6		50	47.3 x 56.7	69	41.4 x 49.6	79	24.1 x 28.9	94	15.3 x 18.3	98								
1.0mm	∞	56.8 x 68.1	54	85.0 x 101.9	132	113.4 x 135.9	241	177.2 x 212.5	629	248.1 x 297.5	1242								
	minimum	35.9 x 43.0	31	37.1 x 44.4	52	34.9 x 41.8	65	22.7 x 27.1	88	14.9 x 17.8	95								
1.5mm (1+0.5)	∞	37.9 x 45.4	33	56.7 x 68.0	84	75.6 x 90.6	156	118.2 x 141.7	420	165.4 x 198.3	834								
	minimum	27.3 x 32.7	22	30.5 x 36.5	41	30.2 x 36.2	54	21.4 x 25.6	84	14.5 x 17.3	93								
5mm	∞	11.4 x 13.6	3	17.0 x 20.4	17	22.7 x 27.2	37	35.4 x 42.5	129	49.6 x 59.5	262								
	minimum	10.2 x 12.3	2	13.6 x 16.2	12	15.5 x 18.6	22	15.3 x 18.4	61	12.2 x 14.6	81								
10mm	∞	x	x	x	x	11.3 x 13.6	11	17.7 x 21.3	66	24.8 x 29.7	140								
	minimum	x	x	x	x	9.1 x 11.0	8	10.8 x 13.0	44	9.9 x 11.9	69								
15mm (10+5)	∞	x	x	x	x	x	x	11.8 x 14.2	46	16.5 x 19.8	99								
	minimum	x	x	x	x	x	x	8.5 x 10.1	35	8.4 x 10.1	61								
20mm	∞	x	x	x	x	x	x	8.8 x 10.6	35	12.4 x 14.9	79								
	minimum	x	x	x	x	x	x	6.9 x 8.3	29	7.3 x 8.7	55								
25mm (20+5)	∞	x	x	x	x	x	x	7.1 x 8.5	29	9.9 x 11.9	66								
	minimum	x	x	x	x	x	x	5.8 x 7.0	25	6.4 x 7.7	50								
30mm (20+10)	∞	x	x	x	x	x	x	x	x	8.3 x 9.9	58								
	minimum	x	x	x	x	x	x	x	x	5.7 x 6.9	46								
35mm (20+10+5)	∞	x	x	x	x	x	x	x	x	7.1 x 8.5	52								
	minimum	x	x	x	x	x	x	x	x	5.2 x 6.2	43								
40mm	∞	x	x	x	x	x	x	x	x	6.2 x 7.4	48								
	minimum	x	x	x	x	x	x	x	x	4.7 x 5.7	41								
45mm (40+5)	∞	x	x	x	x	x	x	x	x	5.5 x 6.6	45								
	minimum	x	x	x	x	x	x	x	x	4.3 x 5.2	39								
50mm (40+10)	∞	x	x	x	x	x	x	x	x	5.0 x 5.9	42								
	minimum	x	x	x	x	x	x	x	x	4.0 x 4.8	37								

Extension Tube Set (Macro Ring) FP-RGST (0.5mm, 1mm, 5mm, 10mm, 20mm and 40mm)

# EXCEEDING 5 MEGAPIXEL LENS + MACRO RING – 1/1.8" FORMAT

W.D. (Working Distance): Object~L1 vertex

1/1.8" FORMAT		FL-CC0820-5MX		FL-CC1218-5MX		FL-CC1618-5MX		FL-CC2518-5MX		FL-CC3524-5MX	
V: 5.4 H: 7.2	Position of Focus Ring	f=8mm F2.0		f=12mm F1.8		f=16mm F1.8		f=25mm F1.8		f=35mm F2.4	
		V x H (mm)	W.D.	V x H (mm)	W.D.	V x H (mm)	W.D.	V x H (mm)	W.D.	V x H (mm)	W.D.
0.5mm	∞	86.5 x 115.4	119	129.5 x 172.7	276	172.7 x 230.3	497	270.0 x 360.0	1254	378.0 x 504.0	2467
	minimum	39.8 x 53.0	50	36.0 x 48.0	69	31.5 x 42.0	79	18.3 x 24.5	94	11.6 x 15.5	98
1.0mm	∞	43.3 x 57.7	54	64.8 x 86.4	132	86.4 x 115.1	241	135.0 x 180.0	629	189.0 x 252.0	1242
	minimum	27.3 x 36.4	31	28.2 x 37.6	52	26.6 x 35.4	65	17.2 x 23.0	88	11.3 x 15.1	95
1.5mm (1+0.5)	∞	28.8 x 38.5	33	43.2 x 57.6	84	57.6 x 76.8	156	90.0 x 120.0	420	126.0 x 168.0	834
	minimum	20.8 x 27.7	22	23.2 x 30.9	41	23.0 x 30.6	54	16.3 x 21.7	84	11.0 x 14.7	93
5mm	∞	8.7 x 11.5	3	13.0 x 17.3	17	17.3 x 23.0	37	27.0 x 36.0	129	37.8 x 50.4	262
	minimum	7.8 x 10.4	2	10.3 x 13.8	12	11.8 x 15.7	22	11.6 x 15.5	61	9.3 x 12.4	81
10mm	∞	X		X		8.6 x 11.5	11	13.5 x 18.0	66	18.9 x 25.2	140
	minimum	X		X		7.0 x 9.3	8	8.3 x 11.0	44	7.6 x 10.1	69
15mm (10+5)	∞	X		X		X		9.0 x 12.0	46	12.6 x 16.8	99
	minimum	X		X		X		6.4 x 8.6	35	6.4 x 8.5	61
20mm	∞	X		X		X		6.7 x 9.0	35	9.4 x 12.6	79
	minimum	X		X		X		5.3 x 7.0	29	5.5 x 7.4	55
25mm (20+5)	∞	X		X		X		5.4 x 7.2	29	7.6 x 10.1	66
	minimum	X		X		X		4.4 x 5.9	25	4.9 x 6.5	50
30mm (20+10)	∞	X		X		X		X		6.3 x 8.4	58
	minimum	X		X		X		X		4.4 x 5.8	46
35mm (20+10+5)	∞	X		X		X		X		5.4 x 7.2	52
	minimum	X		X		X		X		3.9 x 5.3	43
40mm	∞	X		X		X		X		4.7 x 6.3	48
	minimum	X		X		X		X		3.6 x 4.8	41
45mm (40+5)	∞	X		X		X		X		4.2 x 5.6	45
	minimum	X		X		X		X		3.3 x 4.4	39
50mm (40+10)	∞	X		X		X		X		3.8 x 5.0	42
	minimum	X		X		X		X		3.1 x 4.1	37

Extension Tube Set (Macro Ring) FP-RGST (0.5mm, 1mm, 5mm, 10mm, 20mm and 40mm)

# EXCEEDING 5 MEGAPIXEL LENS + MACRO RING – 1/2" FORMAT

W.D. (Working Distance): Object~L1 vertex

1/2" FORMAT		FL-CC0820-5MX		FL-CC1218-5MX		FL-CC1618-5MX		FL-CC2518-5MX		FL-CC3524-5MX	
V: 4.8 H: 6.4	Position of Focus Ring	f=8mm F2.0		f=12mm F1.8		f=16mm F1.8		f=25mm F1.8		f=35mm F2.4	
		V x H (mm)	W.D.	V x H (mm)	W.D.	V x H (mm)	W.D.	V x H (mm)	W.D.	V x H (mm)	W.D.
0.5mm	∞	76.9 x 102.5	119	115.1 x 153.5	276	153.5 x 204.7	497	240.0 x 320.0	1254	336.0 x 448.0	2467
	minimum	35.4 x 47.2	50	32.0 x 42.7	69	28.0 x 37.3	79	16.3 x 21.7	94	10.3 x 13.8	98
1.0mm	∞	38.5 x 51.3	54	57.6 x 76.8	132	76.8 x 102.4	241	120.0 x 160.0	629	168.0 x 224.0	1242
	minimum	24.3 x 32.4	31	25.1 x 33.4	52	23.6 x 31.5	65	15.3 x 20.4	88	10.1 x 13.4	95
1.5mm (1+0.5)	∞	25.6 x 34.2	33	38.4 x 51.2	84	51.2 x 68.2	156	80.0 x 106.7	420	112.0 x 149.3	834
	minimum	18.5 x 24.7	22	20.6 x 27.5	41	20.4 x 27.2	54	14.5 x 19.3	84	9.8 x 13.1	93
5mm	∞	7.7 x 10.3	3	11.5 x 15.4	17	15.4 x 20.5	37	24.0 x 32.0	129	33.6 x 44.8	262
	minimum	6.9 x 9.2	2	9.2 x 12.2	12	10.5 x 14.0	22	10.4 x 13.8	61	8.2 x 11.0	81
10mm	∞	x		x		7.7 x 10.2	11	12.0 x 16.0	66	16.8 x 22.4	140
	minimum	x		x		6.2 x 8.3	8	7.4 x 9.8	44	6.7 x 9.0	69
15mm (10+5)	∞	x		x		x		8.0 x 10.7	46	11.2 x 14.9	99
	minimum	x		x		x		5.7 x 7.6	35	5.7 x 7.6	61
20mm	∞	x		x		x		6.0 x 8.0	35	8.4 x 11.2	79
	minimum	x		x		x		4.7 x 6.2	29	4.9 x 6.6	55
25mm (20+5)	∞	x		x		x		4.8 x 6.4	29	6.7 x 9.0	66
	minimum	x		x		x		3.9 x 5.3	25	4.3 x 5.8	50
30mm (20+10)	∞	x		x		x		x		5.6 x 7.5	58
	minimum	x		x		x		x		3.9 x 5.2	46
35mm (20+10+5)	∞	x		x		x		x		4.8 x 6.4	52
	minimum	x		x		x		x		3.5 x 4.7	43
40mm	∞	x		x		x		x		4.2 x 5.6	48
	minimum	x		x		x		x		3.2 x 4.3	41
45mm (40+5)	∞	x		x		x		x		3.7 x 5.0	45
	minimum	x		x		x		x		2.9 x 3.9	39
50mm (40+10)	∞	x		x		x		x		3.4 x 4.5	42
	minimum	x		x		x		x		2.7 x 3.6	37

Extension Tube Set (Macro Ring) FP-RGST (0.5mm, 1mm, 5mm, 10mm, 20mm and 40mm)

# 9 MEGAPIXEL (1") / 12 MEGAPIXEL (1.1") LENS + MACRO RING – 1.1" FORMAT

W.D. (Working Distance): Object-L1 vertex

1.1" FORMAT		FL-BC1220-9M	FL-BC1618-9M	FL-BC2518-9M	FL-BC3518-9M	FL-BC5024-9M	FL-BC7528-9M						
V: 10.35 H: 14.13	Position of Focus Ring	f=12mm F2.0		f=25mm F1.8		f=50mm F2.4		f=75mm F2.8					
		V x H (mm)	W.D.	V x H (mm)	W.D.	V x H (mm)	W.D.	V x H (mm)	W.D.				
0.5mm	∞	249.0 x 339.9	276	331.4 x 452.4	497	517.3 x 706.2	1244	724.4 x 988.9	2455	1034.9 x 1412.8	5015	1552.4 x 2119.4	11288
	minimum	59.8 x 81.7	58	51.5 x 70.3	65	39.1 x 53.4	92	39.2 x 53.5	142	37.8 x 51.6	193	28.0 x 38.3	246
1.0mm	∞	124.5 x 169.9	131	165.7 x 226.2	241	258.6 x 353.1	620	362.2 x 494.5	1231	517.4 x 706.4	2515	776.2 x 1059.7	5664
	minimum	48.4 x 66.1	45	44.6 x 60.8	55	36.4 x 49.7	86	37.2 x 50.8	136	36.4 x 49.8	187	27.5 x 37.6	243
1.5mm (1+0.5)	∞	83.0 x 113.3	83	110.5 x 150.8	156	172.4 x 235.4	412	241.5 x 329.6	823	345.0 x 470.9	1682	517.5 x 706.5	3789
	minimum	40.7 x 55.5	35	39.3 x 53.6	46	34.1 x 46.5	80	35.5 x 48.4	129	35.2 x 48.0	181	27.1 x 36.9	239
5mm	∞	24.9 x 34.0	15	33.1 x 45.2	36	51.7 x 70.6	120	72.4 x 98.9	251	103.5 x 141.3	516	155.2 x 211.9	1165
	minimum	19.2 x 26.2	10	21.5 x 29.3	19	23.5 x 32.1	54	26.6 x 36.3	99	28.3 x 38.6	148	24.2 x 33.0	218
10mm	∞	x	-	16.6 x 22.6	10	25.9 x 35.3	58	36.2 x 49.4	129	51.7 x 70.6	266	77.6 x 106.0	602
	minimum	x	-	13.0 x 17.8	6	16.3 x 22.3	36	19.6 x 26.8	74	22.1 x 30.1	119	21.0 x 28.6	194
15mm (10+5)	∞	x	-	x	-	17.2 x 23.5	37	24.1 x 33.0	88	34.5 x 47.1	182	51.7 x 70.6	415
	minimum	x	-	x	-	12.5 x 17.0	26	15.5 x 21.2	60	18.1 x 24.7	100	18.5 x 25.3	176
20mm	∞	x	-	x	-	12.9 x 17.7	27	18.1 x 24.7	68	25.9 x 35.3	141	38.8 x 53.0	321
	minimum	x	-	x	-	10.1 x 13.8	20	12.8 x 17.5	51	15.3 x 20.9	88	16.6 x 22.6	162
25mm (20+5)	∞	x	-	x	-	10.3 x 14.1	20	14.5 x 19.8	55	20.7 x 28.3	116	31.0 x 42.4	265
	minimum	x	-	x	-	8.5 x 11.6	16	11.0 x 15.0	44	13.3 x 18.2	78	15.0 x 20.5	150
30mm (20+10)	∞	x	-	x	-	8.6 x 11.8	16	12.1 x 16.5	47	17.2 x 23.5	99	25.9 x 35.3	227
	minimum	x	-	x	-	7.3 x 10.0	14	9.5 x 13.0	39	11.7 x 16.0	71	13.7 x 18.7	141
35mm (20+10+5)	∞	x	-	x	-	7.4 x 10.1	13	10.3 x 14.1	41	14.8 x 20.2	87	22.2 x 30.3	200
	minimum	x	-	x	-	6.4 x 8.8	11	8.5 x 11.6	36	10.5 x 14.4	65	12.6 x 17.2	133
40mm	∞	x	-	x	-	6.5 x 8.8	11	9.1 x 12.4	37	12.9 x 17.7	78	19.4 x 26.5	180
	minimum	x	-	x	-	5.7 x 7.8	10	7.6 x 10.4	33	9.5 x 13.0	60	11.7 x 15.9	126
45mm (40+5)	∞	x	-	x	-	5.7 x 7.8	9	8.0 x 11.0	34	11.5 x 15.7	71	17.2 x 23.5	165
	minimum	x	-	x	-	5.2 x 7.1	8	6.9 x 9.4	30	8.7 x 11.9	56	10.9 x 14.8	120
50mm (40+10)	∞	x	-	x	-	5.2 x 7.1	8	7.2 x 9.9	31	10.3 x 14.1	66	15.5 x 21.2	152
	minimum	x	-	x	-	4.7 x 6.4	7	6.3 x 8.6	28	8.0 x 10.9	53	10.2 x 13.9	115

Extension Tube Set (Macro Ring) FP-RGST  
(0.5mm, 1mm, 5mm, 10mm, 20mm and 40mm)

# 9 MEGAPIXEL (1") / 12 MEGAPIXEL (1.1") LENS + MACRO RING – 1" FORMAT

W.D. (Working Distance): Object-L1 vertex

V: 9.6 H: 12.8	1" FORMAT		FL-BC1220-9M		FL-BC1618-9M		FL-BC2518-9M		FL-BC3518-9M		FL-BC5024-9M		FL-BC7528-9M	
	Position of Focus Ring	f=12mm F2.0		f=16mm F1.8		f=25mm F1.8		f=35mm F1.8		f=50mm F2.4		f=75mm F2.8		
		V x H (mm)	W.D.	V x H (mm)	W.D.	V x H (mm)	W.D.	V x H (mm)	W.D.	V x H (mm)	W.D.	V x H (mm)	W.D.	V x H (mm)
0.5mm	∞	230.9 x 307.9	276	307.4 x 409.8	497	479.8 x 639.8	1244	671.9 x 895.8	2455	959.9 x 1279.9	5015	1439.9 x 1919.9	11288	
	minimum	55.5 x 74.0	58	47.8 x 63.7	65	36.2 x 48.3	92	36.3 x 48.5	142	35.1 x 46.8	193	26.0 x 34.7	246	
1.0mm	∞	115.5 x 153.9	131	153.7 x 204.9	241	239.9 x 319.9	620	335.9 x 447.9	1231	479.9 x 639.9	2515	720.0 x 959.9	5664	
	minimum	44.9 x 59.9	45	41.3 x 55.1	55	33.8 x 45.0	86	34.5 x 46.0	136	33.8 x 45.1	187	25.5 x 34.0	243	
1.5mm (1+0.5)	∞	77.0 x 102.6	83	102.5 x 136.6	156	159.9 x 213.3	412	224.0 x 298.6	823	320.0 x 426.6	1682	480.0 x 640.0	3789	
	minimum	37.7 x 50.3	35	36.4 x 48.6	46	31.6 x 42.1	80	32.9 x 43.8	129	32.6 x 43.5	181	25.1 x 33.5	239	
5mm	∞	23.1 x 30.8	15	30.7 x 41.0	36	48.0 x 64.0	120	67.2 x 89.6	251	96.0 x 128.0	516	144.0 x 192.0	1165	
	minimum	17.8 x 23.7	10	19.9 x 26.5	19	21.8 x 29.1	54	24.7 x 32.9	99	26.2 x 34.9	148	22.4 x 29.9	218	
10mm	∞	x	-	15.4 x 20.5	10	24.0 x 32.0	58	33.6 x 44.8	129	48.0 x 64.0	266	72.0 x 96.0	602	
	minimum	x	-	12.1 x 16.1	6	15.1 x 20.2	36	18.2 x 24.2	74	20.5 x 27.3	119	19.4 x 25.9	194	
15mm (10+5)	∞	x	-	x	-	16.0 x 21.3	37	22.4 x 29.9	88	32.0 x 42.7	182	48.0 x 64.0	415	
	minimum	x	-	x	-	11.6 x 15.4	26	14.4 x 19.2	60	16.8 x 22.4	100	17.2 x 22.9	176	
20mm	∞	x	-	x	-	12.0 x 16.0	27	16.8 x 22.4	68	24.0 x 32.0	141	36.0 x 48.0	321	
	minimum	x	-	x	-	9.4 x 12.5	20	11.9 x 15.9	51	14.2 x 19.0	88	15.4 x 20.5	162	
25mm (20+5)	∞	x	-	x	-	9.6 x 12.8	20	13.4 x 17.9	55	19.2 x 25.6	116	28.8 x 38.4	265	
	minimum	x	-	x	-	7.9 x 10.5	16	10.2 x 13.5	44	12.3 x 16.5	78	13.9 x 18.5	150	
30mm (20+10)	∞	x	-	x	-	8.0 x 10.7	16	11.2 x 14.9	47	16.0 x 21.3	99	24.0 x 32.0	227	
	minimum	x	-	x	-	6.8 x 9.1	14	8.9 x 11.8	39	10.9 x 14.5	71	12.7 x 16.9	141	
35mm (20+10+5)	∞	x	-	x	-	6.9 x 9.1	13	9.6 x 12.8	41	13.7 x 18.3	87	20.6 x 27.4	200	
	minimum	x	-	x	-	6.0 x 8.0	11	7.9 x 10.5	36	9.8 x 13.0	65	11.7 x 15.6	133	
40mm	∞	x	-	x	-	6.0 x 8.0	11	8.4 x 11.2	37	12.0 x 16.0	78	18.0 x 24.0	180	
	minimum	x	-	x	-	5.3 x 7.1	10	7.1 x 9.4	33	8.8 x 11.8	60	10.8 x 14.4	126	
45mm (40+5)	∞	x	-	x	-	5.3 x 7.1	9	7.5 x 10.0	34	10.7 x 14.2	71	16.0 x 21.3	165	
	minimum	x	-	x	-	4.8 x 6.4	8	6.4 x 8.5	30	8.1 x 10.8	56	10.1 x 13.4	120	
50mm (40+10)	∞	x	-	x	-	4.8 x 6.4	8	6.7 x 9.0	31	9.6 x 12.8	66	14.4 x 19.2	152	
	minimum	x	-	x	-	4.4 x 5.8	7	5.9 x 7.8	28	7.4 x 9.9	53	9.4 x 12.6	115	

Extension Tube Set (Macro Ring) FP-RGST (0.5mm, 1mm, 5mm, 10mm, 20mm and 40mm)



**VISION CONSULTANCY**  
MAKING THE UNSEEN VISIBLE

Thank you for downloading this document from  
[www.machine-vision-shop.com](http://www.machine-vision-shop.com)

If you have any questions, you need help composing the  
right package for your application or do you want to order?

Feel free to contact us via e-mail at [sales@vision-consultancy.nl](mailto:sales@vision-consultancy.nl) or visit our webshop.

Our vision experts are happy to help you.



Natascha Overhof



Christian Cromptvoets



**VISION CONSULTANCY**

Robert Schumandomein 2  
6229 ES Maastricht  
The Netherlands

+31 (0) 438 522 651

[sales@vision-consultancy.nl](mailto:sales@vision-consultancy.nl)  
[www.machine-vision-shop.com](http://www.machine-vision-shop.com)

Scan me to visit  
[machine-vision-shop](http://machine-vision-shop.com)

