

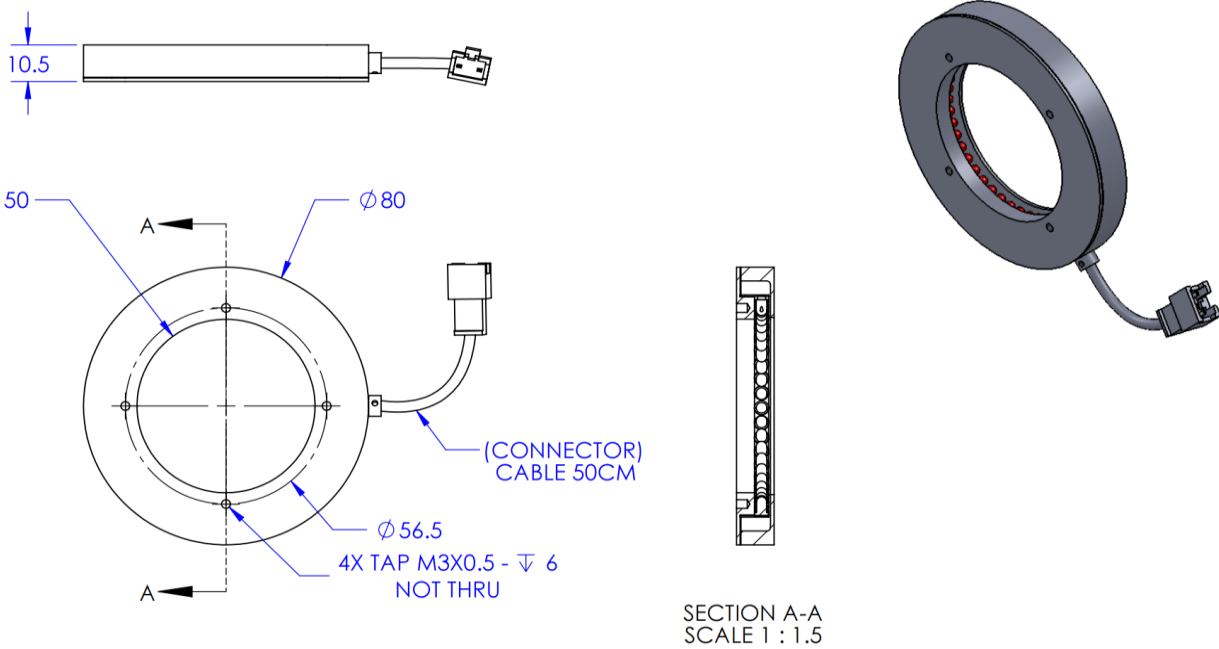

ILLUMINATOR DATA-ID

LLA-90-080-1-G-24V

Lighting Dimension



Mechanical Information	
Casing Material	Aluminium
Storage Temperature Range	Temp 0 - 45°C, Humidity 20-85%
Weight	70 g
Length / Outer Diameter	80 mm
Width / Inner Diameter	50 mm
Thickness / Height	10.5 mm



ILLUMINATOR DATA-ID

LLA-90-080-1-G-24V

Optical Information				
Part Number	LLA-90-080-1-G-24V			
LED Color	GREEN			
Wavelength	(nm)	525		
Intensity (±15%)	(Lux)	6080	1080 514	
Working Distance	(mm)	12	17 22	
Illumination (number of row)	1			
Illumination Active Area				
Active Length / Outer Diameter	(mm)	51		
Active Width / Inner Diameter	(mm)	50		
Emission angle	(deg.)	90		
Eye Safety Class (IEC62471)	EXEMPT			
Electrical Information				
Lighting Supply Voltage (constant voltage mode)	24V ± 2%			
Continuous Current	(mA)	105		
Power Consumption	(W)	2.52		
Lighting casing temperature, Operating after 60 minutes	°C	45.7		
Strobe Mode Specification				
Pulse Operation	YES			
Max. Lighting Supply Voltage (Constant voltage power supply)	(V)	Pulsing at 24VDC to 48VDC, 0-10% Duty Cycle, Recommended at 36VDC		
Pulse Current, (Max. 10msec) (Constant current power supply)	(mA)	315		
Max. Trigger Pulse Duration	(msec)	10		
Duty Cycle	0-10%			
Additional Information				
Additional Cooling Method	Attached to machine part for better heat dissipation			
Intensity Controller Selection	ANG, ST, SD and SDA Series			
CE Conformity	YES			
RoHS Compliance	YES			
Connection				
Connector Type (Default):	JST SMR-03V			
Cable Length out from lighting :	(mm)	500		
Pin Configuration :		Pin	Signal	Cable Color
		1	LED +	RED
		2	N.C.	---
		3	LED -	WHITE
				
Application				
Illumination Type	Direct Illumination			
Applicattion Use	Edge detection, scratched on metal or glossy surface.			



VISION CONSULTANCY
MAKING THE UNSEEN VISIBLE

Thank you for downloading this document from
www.machine-vision-shop.com

If you have any questions, you need help composing the
right package for your application or do you want to order?

Feel free to contact us via e-mail at sales@vision-consultancy.nl or visit our webshop.

Our vision experts are happy to help you.



Natascha Overhof



Christian Cromptoets



VISION CONSULTANCY

Robert Schumandomein 2
6229 ES Maastricht
The Netherlands

+31 (0) 438 522 651

sales@vision-consultancy.nl
www.machine-vision-shop.com

Scan me to visit
[machine-vision-shop](http://machine-vision-shop.com)

