

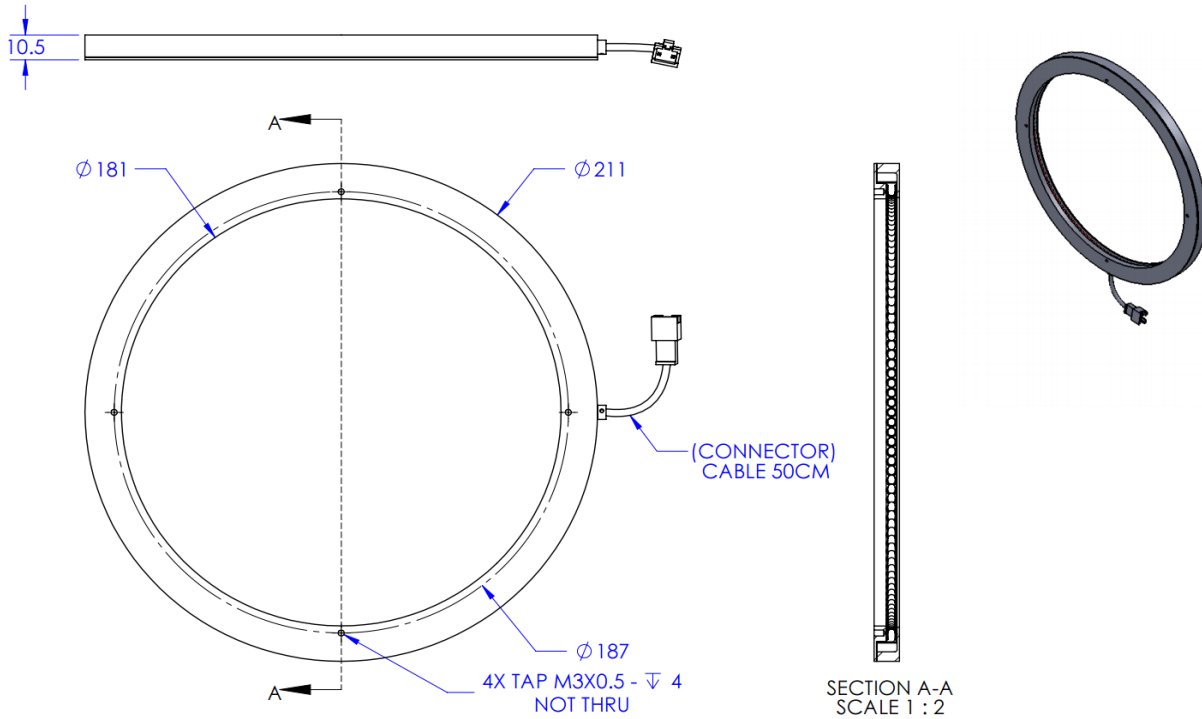

# ILLUMINATOR DATA-ID

## LLA-90-210-1-W-24V

### Lighting Dimension



Mechanical Information	
Casing Material	Aluminium
Storage Temperature Range	Temp 0 - 45°C, Humidity 20-85%
Weight	190 g
Length / Outer Diameter	211 mm
Width / Inner Diameter	181 mm
Thickness / Height	10.5 mm



# ILLUMINATOR DATA-ID

## LLA-90-210-1-W-24V

Optical Information		LLA-90-210-1-W-24V																							
Part Number		LLA-90-210-1-W-24V																							
LED Color		WHITE																							
Wavelength	(nm)	* Refer to the Chromaticity Table Below																							
Intensity (±15%)	(Lux)	8720	9700	8800																					
Working Distance	(mm)	20	25	30																					
Illumination (number of row)		1																							
Illumination Active Area																									
Active Length / Outer Diameter	(mm)	182																							
Active Width / Inner Diameter	(mm)	181																							
Emission angle	(deg.)	90																							
Eye Safety Class ( IEC62471 )		EXEMPT																							
*CHROMATICITY TABLE		<table border="1"> <tr> <td>X</td> <td>0.296</td> <td>0.287</td> <td>0.307</td> <td>0.311</td> <td>X</td> <td>0.311</td> <td>0.307</td> <td>0.33</td> <td>0.33</td> </tr> <tr> <td>Y</td> <td>0.276</td> <td>0.295</td> <td>0.315</td> <td>0.294</td> <td>Y</td> <td>0.294</td> <td>0.315</td> <td>0.339</td> <td>0.318</td> </tr> </table>				X	0.296	0.287	0.307	0.311	X	0.311	0.307	0.33	0.33	Y	0.276	0.295	0.315	0.294	Y	0.294	0.315	0.339	0.318
X	0.296	0.287	0.307	0.311	X	0.311	0.307	0.33	0.33																
Y	0.276	0.295	0.315	0.294	Y	0.294	0.315	0.339	0.318																
Electrical Information																									
Lighting Supply Voltage (constant voltage mode)		24V ± 2%																							
Continuous Current	(mA)	300																							
Power Consumption	(W)	7.2																							
Lighting casing temperature, Operating after 60 minutes	°C	45.1																							
Strobe Mode Specification																									
Pulse Operation		YES																							
Max. Lighting Supply Voltage (Constant voltage power supply)	(V)	Pulsing at 24VDC to 48VDC, 0-10% Duty Cycle, Recommended at 36VDC																							
Pulse Current, (Max. 10msec) (Constant current power supply)	(mA)	900																							
Max. Trigger Pulse Duration	(msec)	10																							
Duty Cycle		0-10%																							
Additional Information																									
Additional Cooling Method		Attached to machine part for better heat dissipation																							
Intensity Controller Selection		ANG, ST, SD and SDA Series																							
CE Conformity		YES																							
RoHS Compliance		YES																							
Connection																									
Connector Type (Default):		JST SMR-03V																							
Cable Length out from lighting :	(mm)	500																							
Pin Configuration :		Pin	Signal	Cable Color																					
		1	LED +	RED																					
		2	N.C.	---																					
		3	LED -	WHITE																					
																									
Application																									
Illumination Type		Direct Illumination																							
Applicattion Use		Edge detection, scratched on metal or glossy surface.																							



**VISION CONSULTANCY**  
MAKING THE UNSEEN VISIBLE

Thank you for downloading this document from  
[www.machine-vision-shop.com](http://www.machine-vision-shop.com)

If you have any questions, you need help composing the  
right package for your application or do you want to order?

Feel free to contact us via e-mail at [sales@vision-consultancy.nl](mailto:sales@vision-consultancy.nl) or visit our webshop.

Our vision experts are happy to help you.



Natascha Overhof



Christian Cromptvoets



**VISION CONSULTANCY**

Robert Schumandomein 2  
6229 ES Maastricht  
The Netherlands

+31 (0) 438 522 651

[sales@vision-consultancy.nl](mailto:sales@vision-consultancy.nl)  
[www.machine-vision-shop.com](http://www.machine-vision-shop.com)

Scan me to visit  
[machine-vision-shop](http://machine-vision-shop.com)

