

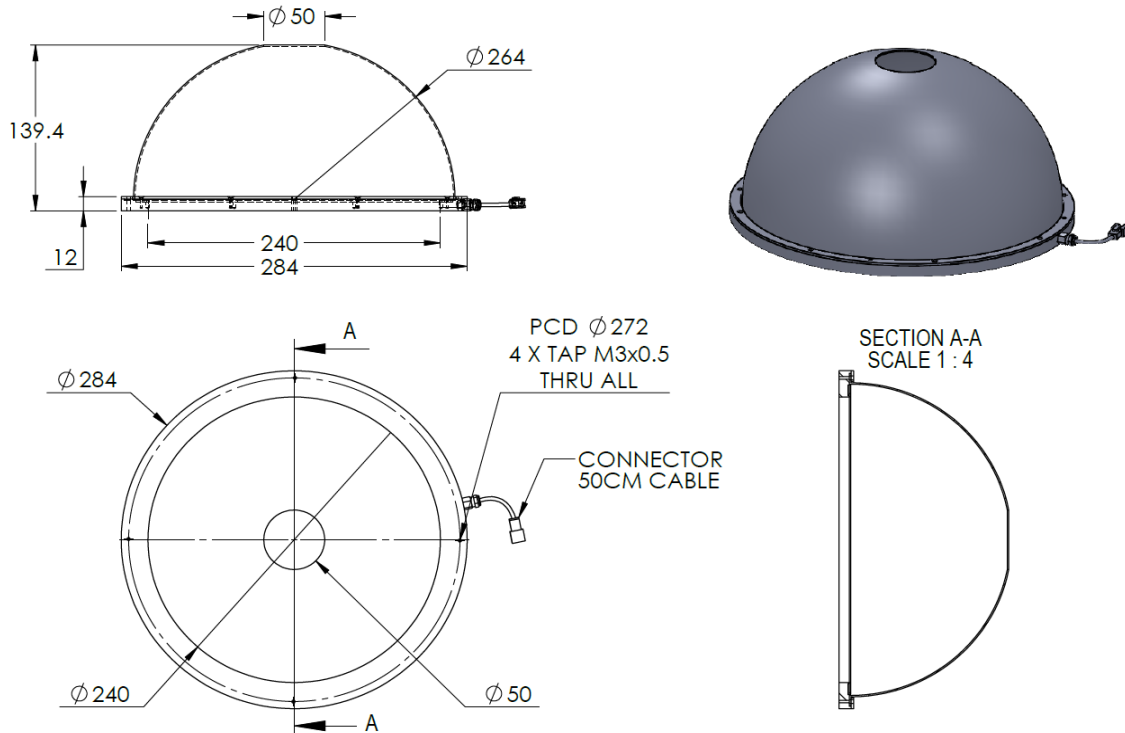

ILLUMINATOR DATA-ID

IDS5-00-250-1-W-24V

Lighting Dimension



Mechanical Information	
Casing Material	Aluminium
Storage Temperature Range	Temp 0-45°C, Humidity 20-85%
Weight	780 g
Length / Outer Diameter	284 mm
Width / Inner Diameter	50 mm
Thickness / Height	139.4 mm



ILLUMINATOR DATA-ID

IDS5-00-250-1-W-24V

Optical Information		IDS5-00-250-1-W-24V																					
Part Number		IDS5-00-250-1-W-24V																					
LED Color		WHITE																					
Wavelength	(nm)	*Refer to the Chromaticity Table below																					
Intensity (±15%)	(Lux)	38300	30800	25700																			
Working Distance	(mm)	50	80	100																			
Illumination (number of row)		1																					
Illumination Active Area																							
Active Length / Outer Diameter	(mm)	240																					
Active Width / Inner Diameter	(mm)	50																					
Emission angle	(deg.)	0																					
Eye Safety Class (IEC62471)		EXEMPT																					
*CHROMATICITY TABLE		<table border="1"> <tr> <td>X</td> <td>0.296</td> <td>0.287</td> <td>0.307</td> <td>0.311</td> </tr> <tr> <td>Y</td> <td>0.276</td> <td>0.295</td> <td>0.315</td> <td>0.294</td> </tr> </table>	X	0.296	0.287	0.307	0.311	Y	0.276	0.295	0.315	0.294	<table border="1"> <tr> <td>X</td> <td>0.311</td> <td>0.307</td> <td>0.33</td> <td>0.33</td> </tr> <tr> <td>Y</td> <td>0.294</td> <td>0.315</td> <td>0.339</td> <td>0.318</td> </tr> </table>	X	0.311	0.307	0.33	0.33	Y	0.294	0.315	0.339	0.318
X	0.296	0.287	0.307	0.311																			
Y	0.276	0.295	0.315	0.294																			
X	0.311	0.307	0.33	0.33																			
Y	0.294	0.315	0.339	0.318																			
Electrical Information																							
Lighting Supply Voltage (constant voltage mode)		24V ± 2%																					
Continuous Current	(mA)	1600																					
Power Consumption	(W)	38.4																					
Lighting casing temperature, Operating after 60 minutes	°C	57																					
Strobe Mode Specification																							
Pulse Operation		YES																					
Max. Lighting Supply Voltage (Constant voltage power supply)	(V)	Pulsing at 24VDC to 48VDC, 0-10% Duty Cycle, Recommended at 36VDC																					
Pulse Current, (Max. 10msec) (Constant current power supply)	(mA)	4800																					
Max. Trigger Pulse Duration	(msec)	10																					
Duty Cycle		0-10%																					
Additional Information																							
Additional Cooling Method		Attached to machine part for better heat dissipation																					
Intensity Controller Selection		ANGX, ST, SD and SDA Series																					
CE Conformity		YES																					
RoHS Compliance		YES																					
Connection																							
Connector Type (Default):		JST SMR-03V																					
Cable Length out from lighting :	(mm)	500																					
Pin Configuration :		Pin	Signal	Cable Color																			
		1	LED +	RED																			
		2	N.C.	---																			
		3	LED -	WHITE																			
																							
Application																							
Illumination Type		Indirect Illumination																					
Applicattion Use		Crack, chip, stains on circular or cylindrical objects, solder inspection and subtract inspection.																					



ILLUMINATOR DATA-ID

IDS5-00-250-1-W-24V

Uniform Graph (Relative Irradiation Strength) - Representative pattern

Lens focal length, $f = 0$
CWD = 293mm
LWD = 50mm, 80mm, 100mm
Lighting angle: 0°

Tolerance	L X W
10%	114 X 85
20%	114 X 85
30%	114 X 85
40%	114 X 85

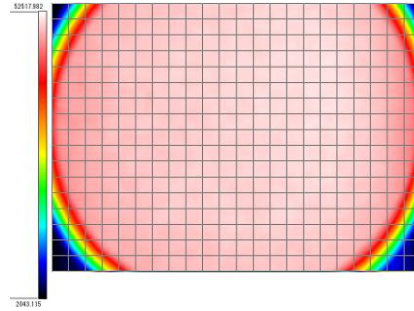
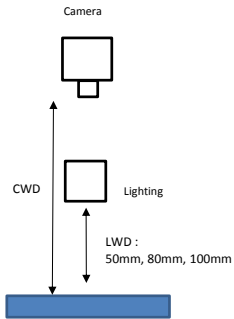

* 1 cell = 5mm x 5mm



VISION CONSULTANCY
MAKING THE UNSEEN VISIBLE

Thank you for downloading this document from
www.machine-vision-shop.com

If you have any questions, you need help composing the
right package for your application or do you want to order?

Feel free to contact us via e-mail at sales@vision-consultancy.nl or visit our webshop.

Our vision experts are happy to help you.



Natascha Overhof



Christian Cromptvoets



VISION CONSULTANCY

Robert Schumandomein 2
6229 ES Maastricht
The Netherlands

+31 (0) 438 522 651

sales@vision-consultancy.nl
www.machine-vision-shop.com

Scan me to visit
[machine-vision-shop](http://machine-vision-shop.com)

