

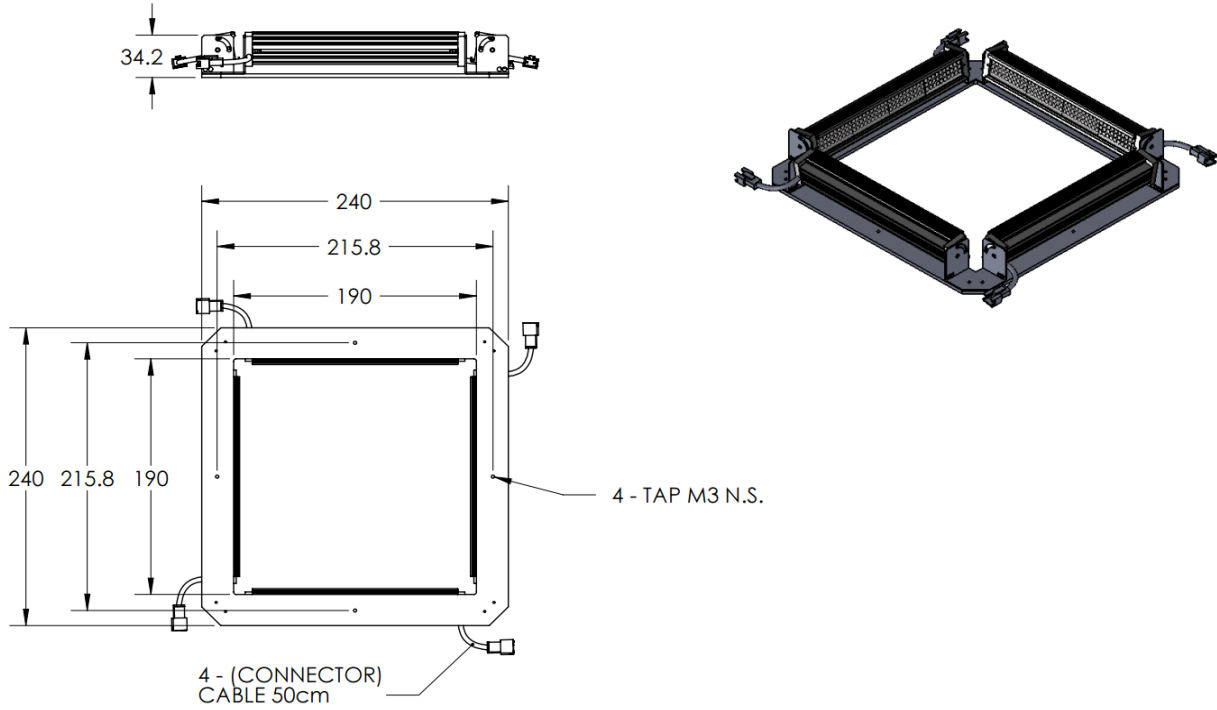

ILLUMINATOR DATA-ID

LBRQ-00-160-3-R-24V

Lighting Dimension



Mechanical Information	
Casing Material	Aluminium
Storage Temperature Range	Temp 0 - 45°C, Humidity 20-85%
Weight	740 g
Length / Outer Diameter	240 mm
Width / Inner Diameter	190 mm
Thickness / Height	34.2 mm



ILLUMINATOR DATA-ID

LBRQ-00-160-3-R-24V

Optical Information				
Part Number		LBRQ-00-160-3-R-24V		
LED Color		RED		
Wavelength	(nm)	630		
Intensity (±15%)	(Lux)	TBA	TBA	TBA
Working Distance	(mm)	280	291	302
Illumination (number of row)		3		
Illumination Active Area				
Active Length / Outer Diameter	(mm)	240		
Active Width / Inner Diameter	(mm)	190		
Emission angle	(deg.)	0		
Eye Safety Class (IEC62471)		EXEMPT		
Electrical Information				
Lighting Supply Voltage (constant voltage mode)		24V ± 2%		
Continuous Current	(mA)	528		
Power Consumption	(W)	12.67		
Lighting casing temperature, Operating after 60 minutes	°C	35.4		
Strobe Mode Specification				
Pulse Operation		YES		
Max. Lighting Supply Voltage (Constant voltage power supply)	(V)	Pulsing at 24VDC to 48VDC, 0-10% Duty Cycle, Recommended at 36VDC		
Pulse Current, (Max. 10msec) (Constant current power supply)	(mA)	1584		
Max. Trigger Pulse Duration	(msec)	10		
Duty Cycle		0-10%		
Additional Information				
Additional Cooling Method		Attached to machine part for better heat dissipation		
Intensity Controller Selection		ANG, ST, SD and SDA Series		
CE Conformity		YES		
RoHS Compliance		YES		
Connection				
Connector Type (Default):		JST SMR-03V		
Cable Length out from lighting :	(mm)	500		
Pin Configuration :		Pin	Signal	Cable Color
		1	LED +	RED
		2	N.C.	---
		3	LED -	WHITE
				
Application				
Illumination Type		Direct Illumination		
Appicattion Use		General illumination, label inspection, character inspection, code recognition.		



VISION CONSULTANCY
MAKING THE UNSEEN VISIBLE

Thank you for downloading this document from
www.machine-vision-shop.com

If you have any questions, you need help composing the
right package for your application or do you want to order?

Feel free to contact us via e-mail at sales@vision-consultancy.nl or visit our webshop.

Our vision experts are happy to help you.



Natascha Overhof



Christian Cromptvoets



VISION CONSULTANCY

Robert Schumandomein 2
6229 ES Maastricht
The Netherlands

+31 (0) 438 522 651

sales@vision-consultancy.nl
www.machine-vision-shop.com

Scan me to visit
[machine-vision-shop](http://machine-vision-shop.com)

