

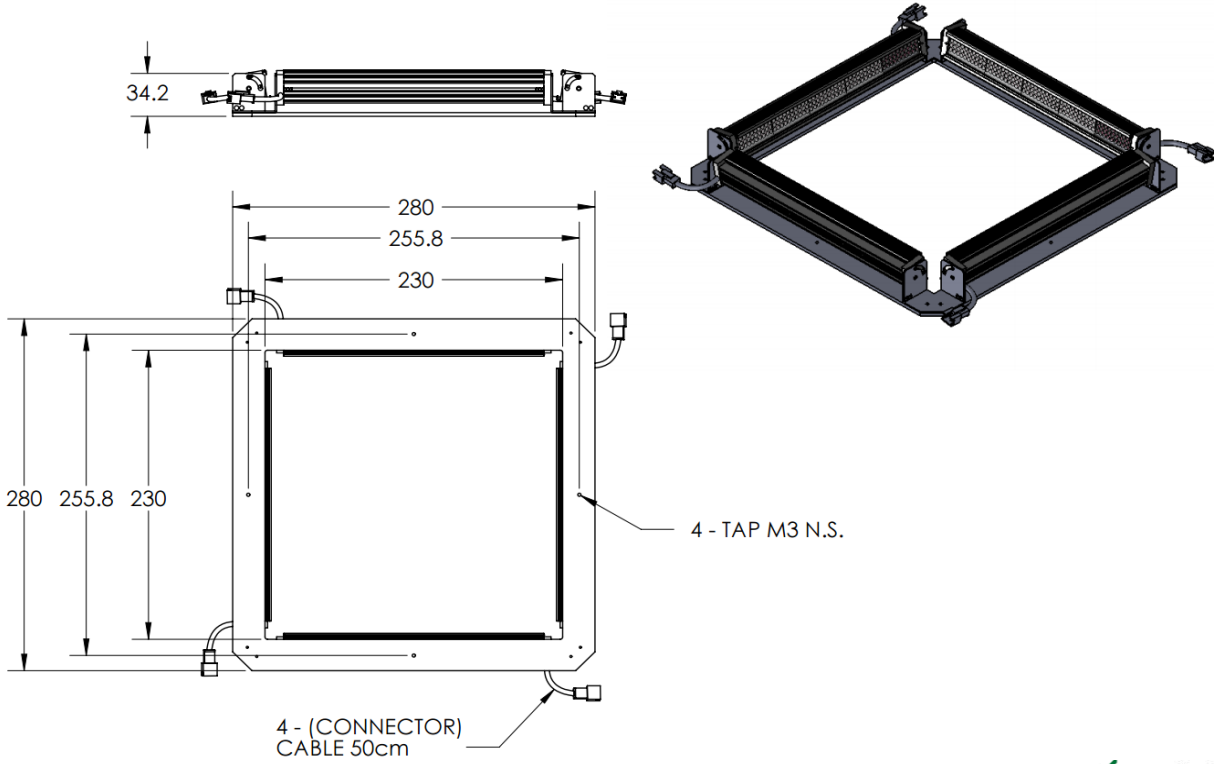

# ILLUMINATOR DATA-ID

## LBRQ-00-200-3-G-24V

### Lighting Dimension



Mechanical Information	
Casing Material	Aluminium
Storage Temperature Range	Temp 0 - 45°C, Humidity 20-85%
Weight	900 g
Length / Outer Diameter	280 mm
Width / Inner Diameter	230 mm
Thickness / Height	34.2 mm



# ILLUMINATOR DATA-ID

## LBRQ-00-200-3-G-24V

Optical Information				
Part Number		LBRQ-00-200-3-G-24V		
LED Color		GREEN		
Wavelength	(nm)	525		
Intensity (±15%)	(Lux)	TBA	TBA	TBA
Working Distance	(mm)	335	346	357
Illumination (number of row)		3		
Illumination Active Area				
Active Length / Outer Diameter	(mm)	280		
Active Width / Inner Diameter	(mm)	230		
Emission angle	(deg.)	0		
Eye Safety Class ( IEC62471 )		EXEMPT		
Electrical Information				
Lighting Supply Voltage (constant voltage mode)		24V ± 2%		
Continuous Current	(mA)	840		
Power Consumption	(W)	20.16		
Lighting casing temperature, Operating after 60 minutes	°C	TBA		
Strobe Mode Specification				
Pulse Operation		YES		
Max. Lighting Supply Voltage (Constant voltage power supply)	(V)	Pulsing at 24VDC to 48VDC, 0-10% Duty Cycle, Recommended at 36VDC		
Pulse Current, (Max. 10msec) (Constant current power supply)	(mA)	2520		
Max. Trigger Pulse Duration	(msec)	10		
Duty Cycle		0-10%		
Additional Information				
Additional Cooling Method		Attached to machine part for better heat dissipation		
Intensity Controller Selection		ANG, ST, SD and SDA Series		
CE Conformity		YES		
RoHS Compliance		YES		
Connection				
Connector Type (Default):		JST SMR-03V		
Cable Length out from lighting :	(mm)	500		
Pin Configuration :		Pin	Signal	Cable Color
		1	LED +	RED
		2	N.C.	---
		3	LED -	WHITE
				
Application				
Illumination Type		Direct Illumination		
Appicattion Use		General illumination, label inspection, character inspection, code recognition.		



**VISION CONSULTANCY**  
MAKING THE UNSEEN VISIBLE

Thank you for downloading this document from  
[www.machine-vision-shop.com](http://www.machine-vision-shop.com)

If you have any questions, you need help composing the  
right package for your application or do you want to order?

Feel free to contact us via e-mail at [sales@vision-consultancy.nl](mailto:sales@vision-consultancy.nl) or visit our webshop.

Our vision experts are happy to help you.



Natascha Overhof



Christian Cromptvoets



**VISION CONSULTANCY**

Robert Schumandomein 2  
6229 ES Maastricht  
The Netherlands

+31 (0) 438 522 651

[sales@vision-consultancy.nl](mailto:sales@vision-consultancy.nl)  
[www.machine-vision-shop.com](http://www.machine-vision-shop.com)

Scan me to visit  
[machine-vision-shop](http://machine-vision-shop.com)

