

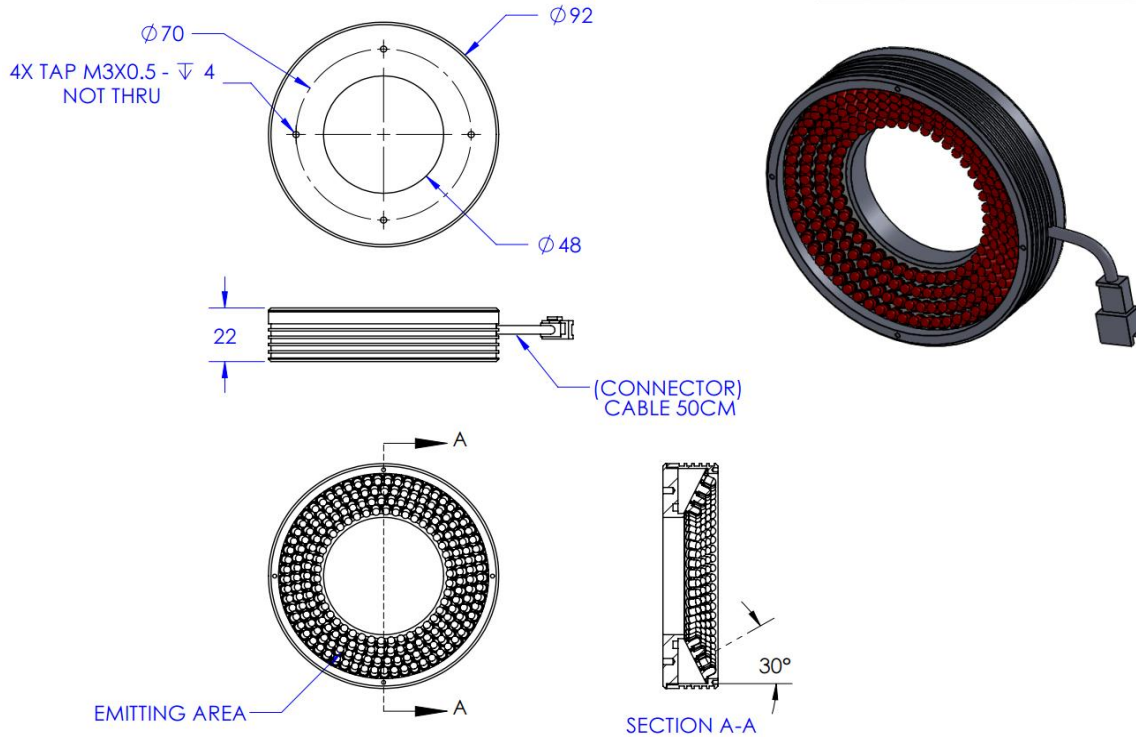

ILLUMINATOR DATA-ID

LSW-30-090-4-W-12V

Lighting Dimension



Mechanical Information	
Casing Material	Aluminium
Storage Temperature Range	Temp 0 - 45°C, Humidity 20-85%
Weight	200 g
Length / Outer Diameter	92 mm
Width / Inner Diameter	48 mm
Thickness / Height	22 mm



ILLUMINATOR DATA-ID

LSW-30-090-4-W-12V

Optical Information																									
Part Number		LSW-30-090-4-W-12V																							
LED Color		WHITE																							
Wavelength	(nm)	* Refer to the Chromaticity Table Below																							
Intensity (±15%)	(Lux)	87100	68600	54500																					
Working Distance	(mm)	41	51	61																					
Illumination (number of row)		4																							
Illumination Active Area																									
Active Length / Outer Diameter	(mm)	84																							
Active Width / Inner Diameter	(mm)	48																							
Emission angle	(deg.)	30																							
Eye Safety Class (IEC62471)		EXEMPT																							
*CHROMATICITY TABLE		<table border="1"> <tr> <td>X</td> <td>0.296</td> <td>0.287</td> <td>0.307</td> <td>0.311</td> <td>X</td> <td>0.311</td> <td>0.307</td> <td>0.33</td> <td>0.33</td> </tr> <tr> <td>Y</td> <td>0.276</td> <td>0.295</td> <td>0.315</td> <td>0.294</td> <td>Y</td> <td>0.294</td> <td>0.315</td> <td>0.339</td> <td>0.318</td> </tr> </table>				X	0.296	0.287	0.307	0.311	X	0.311	0.307	0.33	0.33	Y	0.276	0.295	0.315	0.294	Y	0.294	0.315	0.339	0.318
X	0.296	0.287	0.307	0.311	X	0.311	0.307	0.33	0.33																
Y	0.276	0.295	0.315	0.294	Y	0.294	0.315	0.339	0.318																
Electrical Information																									
Lighting Supply Voltage (constant voltage mode)		12V ± 2%																							
Continuous Current	(mA)	469																							
Power Consumption	(W)	5.63																							
Lighting casing temperature, Operating after 60 minutes	°C	51.3																							
Strobe Mode Specification																									
Pulse Operation		YES																							
Max. Lighting Supply Voltage (Constant voltage power supply)	(V)	Pulsing at 12VDC to 24VDC, 0-10% Duty Cycle, Recommended at 18VDC																							
Pulse Current, (Max. 10msec) (Constant current power supply)	(mA)	1407																							
Max. Trigger Pulse Duration	(msec)	10																							
Duty Cycle		0-10%																							
Additional Information																									
Additional Cooling Method		Attached to machine part for better heat dissipation																							
Intensity Controller Selection		ANG, ST, SD and SDA Series																							
CE Conformity		YES																							
RoHS Compliance		YES																							
Connection																									
Connector Type (Default):		JST SMR-02V																							
Cable Length out from lighting :	(mm)	500																							
Pin Configuration :		Pin	Signal	Cable Color																					
		1	LED +	RED																					
		2	LED -	WHITE																					
																									
Application																									
Illumination Type		Direct Illumination																							
Application Use		Substrate inspection, label inspection, flat surface, fiducially recognition.																							



VISION CONSULTANCY
MAKING THE UNSEEN VISIBLE

Thank you for downloading this document from
www.machine-vision-shop.com

If you have any questions, you need help composing the
right package for your application or do you want to order?

Feel free to contact us via e-mail at sales@vision-consultancy.nl or visit our webshop.

Our vision experts are happy to help you.



Natascha Overhof



Christian Cromptvoets



VISION CONSULTANCY

Robert Schumandomein 2
6229 ES Maastricht
The Netherlands

+31 (0) 438 522 651

sales@vision-consultancy.nl
www.machine-vision-shop.com

Scan me to visit
[machine-vision-shop](http://machine-vision-shop.com)

